

BARCO

BARCO PROJECTION SYSTEMS

BARCO CINE 5

R9002410
R9002419

OWNER'S MANUAL

Federal communication commission (FCC statement)

This equipment has been tested and found to comply with the limits for a class A digital device, pursuant to Part 15 of the FCC Rules and EN55022. These limits are designed to provide reasonable protection against harmful interference when the equipment is operated in a commercial environment. This equipment generates, uses, and can radiate radio frequency energy and, if not installed and used in accordance with the instruction manual, may cause harmful interference to radio communications. Operation of this equipment in a residential area is likely to cause harmful interference in which case the user will be required to correct the interference at his own expense.

Instructions to the user :

if this equipment does cause interference to radio or television reception, the user may try to correct the interference by one or more of the following measures :

- Re-orientation of the receiving antenna for the radio or television.
- Relocate the equipment with respect to the receiver.
- Plug the equipment into a different outlet so that the equipment and receiver are on different branch circuits.
- Fasten cables connectors to the equipment by mounting screws.

Note : The use of shielded cables is required to comply within the limits of Part15 of FCC rules and EN55022.

Due to constant research, the information in this manual is subject to change without notice.

Produced by BARCO NV, April, 2000
All rights reserved.

Trademarks are the rights of their respective owners.

BARCO n.v./Projection Systems

Noordlaan 5
B-8520 Kuurne
Belgium
Tel : +32/56/368211
Fax : +32/56/351651
E-mail : sales.bps@barco.com
Visite Barco at the web : <http://www.barco.com>

Printed in Belgium

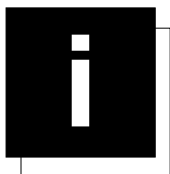
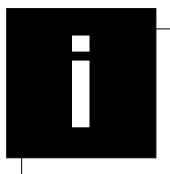

TABLE OF CONTENTS

SAFETY INSTRUCTIONS	1-1
On Safety	1-3
On installation	1-3
On servicing	1-3
On cleaning	1-3
On repacking	1-3
On illumination	1-3
LOCATIONS AND FUNCTIONS OF CONTROL	2-1
Rear Panel Terminology	2-1
Front Panel Terminology	2-1
Control Panel Terminology	2-2
a. Local keypad	2-2
b. RCU control panel terminology	2-2
CONNECTIONS	3-1
Switching on / off	3-1
Signal input to the projector	3-1
Power (mains) cord connection	3-1
Connecting a Composite Video source	3-2
Connecting a S-Video source	3-2
Connecting a RGB Analog source with composite sync	3-3
Connecting a Component Video source	3-4
Connecting a RF signal (optional)	3-4
Peripheral equipment	3-5
Connecting a RCVDS 05 switcher	3-5
Connecting a VS05 switcher	3-5
Connecting an IR Remote Receiver	3-6
CONTROLLING	4-1
Battery installation in the RCU	4-1
How to use the RCU	4-2
Projector Address	4-2
How to Display a Projector Address	4-2
How to Program an Address into the RCU?	4-3
Input selection	4-3
Picture controls	4-4
The Pause key	4-4
Sound control with the RCU (optional)	4-5
START UP OF THE ADJUSTMENT MODE	5-1
Adjustment Mode	5-1
RANDOM ACCESS ADJUSTMENT MODE	6-1
Starting up the Random Access Adjustment Mode	6-1
6-1 Overview 'Random Access Adjustment Mode'	6-1
Selecting Setup Pattern	6-2
Internal Cross-Hatch Pattern	6-2
Selection Menu	6-2
Picture Tuning	6-2
Color Balance	6-3
Gamma	6-3
Decoding	6-3
Color Select	6-4
Geometry adjustments	6-4
Horizontal Phase adjustment	6-5



Raster Shift Adjustment	6-5
East-West (Left-Right) adjustments	6-7
North-South (Top-Bottom) adjustments	6-8
Horizontal Size adjustment	6-9
Vertical Linearity Adjustment	6-9
Vertical Size Adjustment	6-10
Blanking adjustment	6-10
Convergence Adjustment	6-12
SERVICE MODE	7-1
Starting up the Service Mode	7-1
Overview flowchart 'Service' mode	7-2
Projector Set-up	7-3
Identification	7-3
Total Run Time	7-3
Change Password	7-3
Change Projector Address	7-4
Change baud rate	7-4
Power up mode	7-4
Memory Management	7-5
Copy a Block	7-5
Deletion of Blocks	7-5
Deleting Block by Block	7-6
Deletion of all Blocks	7-7
All Settings to midpos	7-7
Undo All settings to Midpos	7-7
R & B convergence to mid	7-8
Undo R & B convergence to mid	7-8
Green convergence mid	7-8
Undo Green convergence mid	7-8
Common Settings	7-9
G2 adjustment	7-9
CRT Run-in cycle	7-9
I2C Diagnostics	7-9
OPTIONS	8-1
IR Receiver 800	8-1
Hardwired RCU	8-1
RCVDS 05 Source Selector	8-1
VS05 Switcher	8-1
Adapter and communication cables	8-1
Ceiling Mount CM50	8-1
Tuner kit	8-2
APPENDIX A : TUNER MODE	A-1
Tuner Mode	A-1
How to activate the tuner mode	A-1
Tuner Set-up	A-2
Broadcasting System	A-2
Auto Search	A-3
Manual Search	A-3
Organise Channel List	A-4
Bilingual	A-4
Teletext	A-5

1

SAFETY INSTRUCTIONS

Notice on Safety

This equipment is built in accordance with the requirements of the international safety standards EN60950, UL 1950 and CSA C22.2 No.950, which are the safety standards of information technology equipment including electrical business equipment.

These safety standards impose important requirements on the use of safety critical components, materials and isolation, in order to protect the user or operator against risk of electric shock and energy hazard, and having access to live parts. Safety standards also impose limits to the internal and external temperature rises, radiation levels, mechanical stability and strength, enclosure construction and protection against the risk of fire.

Simulated single fault condition testing ensures the safety of the equipment to the user even when the equipment's normal operation fails.

INSTALLATION INSTRUCTIONS

Before operating this equipment please read this manual thoroughly, and retain it for future reference. Installation and preliminary adjustments should be performed by qualified BARCO personnel or by authorized BARCO service dealers.

OWNER'S RECORD

The part number and serial number are located at the back side of the projector. Record these numbers in the spaces provided below. Refer to them whenever you call upon your BARCO dealer regarding this product.

PART NUMBER :

SER. NUMBER :

DEALER :

SAFETY INDICATION ON THE PRODUCT

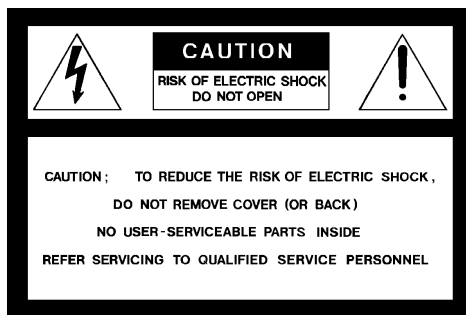

The lightning flash with an arrowhead within a triangle is intended to tell the user that parts inside this product may cause a risk of electrical shock to persons.



The exclamation point within a triangle is intended to tell the user that important operating and/or servicing instructions are included in the technical documentation for this equipment.

WARNING
TO PREVENT FIRE OR ELECTRICAL SHOCK HAZARD, DO NOT EXPOSE THIS EQUIPMENT TO RAIN OR MOISTURE

FEDERAL COMMUNICATION COMMISSION (FCC STATEMENT)

This equipment has been tested and found to comply with the limits of a class B digital device, pursuant to Part 15 of the FCC Rules and EN55022.

These limits are designed to provide reasonable protection against harmful interference when the equipment is operated in a residential environment. This equipment generates, uses and can radiate radio frequency energy and, if not installed and used in accordance with the instruction manual, may cause harmful interference to radio communications. However, there is no guarantee that interference will not occur in a particular installation. If this equipment does cause harmful interference to radio or television reception, which can be determined by turning the equipment off and on, the user is encouraged to try to correct the interference by one or more of the following measures :

- Reorient or relocate the receiving antenna.
- Increase the separation between the equipment and receiver.
- Connect the equipment into an outlet on a circuit different from that to which the receiver is connected.
- Consult the dealer or an experienced radio/TV technician for help.

Note : The use of shielded cables is required to comply within the limits of Part 15 of FCC rules and EN55022.

- ⊗ All the safety and operating instructions should be read before using this unit.
- ⊗ The safety and operating instructions manual should be retained for future reference.
- ⊗ All warnings on the equipment and in the documentation manuals should be adhered to.
- ⊗ All instructions for operating and use of this equipment must be followed precisely.

On safety

1. This product should be operated from an AC power source.
This projector may be connected to an IT-power system.

Operating AC power voltage of the projector:

BARCO CINE 5 : Art. No. R9002410 (230V AC)
Art. No. R9002419 (120V AC)

Consult your dealer to switch over from 230Vac to 120 Vac or from 120Vac to 230 Vac.
If you are not sure of the type of AC power available, consult your dealer or local power company.

2. This product is equipped with a 3-wire grounding plug, a plug having a third (grounding) pin. This plug will only fit into a grounding-type power outlet. This is a safety feature. If you are unable to insert the plug into the outlet, contact your electrician to replace your obsolete outlet. Do not defeat the purpose of the grounding-type plug.

WARNING FOR THE CUSTOMER : THIS APPARATUS MUST BE GROUNDED (EARTHED) via the supplied 3 conductor AC power cable. (If the supplied power cable is not the correct one, consult your dealer.)

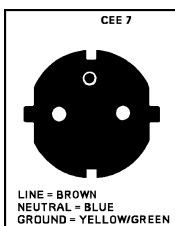

A. Mains lead (Power cord) with CEE 7 plug:

The wires of the mains lead are colored in accordance with the following code.

- Green and yellow : Earth (safety earth)
- Blue : Neutral
- Brown : Line (live)

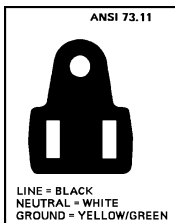

B. Power cord with ANSI 73.11 plug:

The wires of the power cord are colored in accordance with the following code.

- Green/yellow : Ground
- White : Neutral
- Black : Line (live)

3. Do not allow anything to rest on the power cord. Do not locate this product where persons will walk on the cord.
To disconnect the cord, pull it out by the plug. Never pull the cord itself.
4. If an extension cord is used with this product, make sure that the total of the ampere ratings on the products plugged into the extension cord does not exceed the extension cord ampere rating. Also make sure that the total of all products plugged into the wall outlet does not exceed 15 amperes.
5. Never push objects of any kind into this product through cabinet slots as they may touch dangerous voltage points or short out parts that could result in a risk of fire or electrical shock.
Never spill liquid of any kind on the product. Should any liquid or solid object fall into the cabinet, unplug the set and have it checked by qualified service personnel before resuming operations.
6. Lightning - For added protection for this video product during a lightning storm, or when it is left unattended and unused for long periods of time, unplug it from the wall outlet. This will prevent damage to the projector due to lightning and AC power-line surges.

On installation

1. Do not place this equipment on an unstable cart, stand, or table. The product may fall, causing serious damage to it.
2. Do not use this equipment near water.
3. Slots and openings in the cabinet and the back or bottom are provided for ventilation; to ensure reliable operation of the product and to protect it from overheating, these openings must not be blocked or covered. The openings should never be blocked by placing the product on a bed, sofa, rug, or other similar surface. This product should never be placed near or over a radiator or heat register.
The projector should not be placed in a built-in installation or enclosure unless proper ventilation is provided.
4. Do not block the projector cooling fans or free air movement under and around the projector. Loose papers or other objects may not be nearer to the projector than 4" on any side.

On servicing

Do not attempt to service this product yourself, as opening or removing covers may expose you to dangerous voltage potential and risk of electric shock!

Refer all servicing to qualified service personnel.

Unplug this product from the wall outlet and refer servicing to qualified service personnel under the following conditions :

- a. When the power cord or plug is damaged or frayed.
- b. If liquid has been spilled into the equipment.
- c. If the product has been exposed to rain or water.
- d. If the product does not operate normally when the operating instructions are followed.
- e. If the product has been dropped or the cabinet has been damaged.
- f. If the product exhibits a distinct change in performance, indicating a need for service.

Note : Adjust only those controls that are covered by the operating instructions since improper adjustment of the other controls may result in damage and will often require extensive work by a qualified technician to restore the product to normal operation.

Replacement parts - When replacement parts are required, be sure the service technician has used original BARCO replacement parts or authorized replacement parts which have the same characteristics as the BARCO original part. Unauthorized substitutions may result in degraded performance and reliability, fire, electric shock or other hazards. Unauthorized substitutions may void warranty.

Safety check - Upon completion of any service or repairs to this projector, ask the service technician to perform safety checks to determine that the product is in proper operating condition.

On cleaning

Unplug this product from the wall outlet before cleaning. Do not use liquid cleaners or aerosol cleaners. Use a damp cloth for cleaning.

- To keep the cabinet looking brand-new, periodically clean it with a soft cloth. Stubborn stains may be removed with a cloth lightly dampened with mild detergent solution. Never use strong solvents, such as thinner or benzine, or abrasive cleaners, since these will damage the cabinet.
- To ensure the highest optical performance and resolution, the projection lenses are specially treated with an anti-reflective coating, therefore, avoid touching the lens. To remove dust on the lens, use a soft dry cloth. Do not use a damp cloth, detergent solution, or thinner.

On repacking

Save the original shipping carton and packing material; they will come in handy if you ever have to ship your equipment. For maximum protection, repack your set as it was originally packed at the factory.

On illumination

In order to obtain the best quality for the projected image, it is essential that the ambient light which is allowed to fall on the screen be kept to an absolute minimum.

When installing the projector and screen, care must be taken to avoid exposure to ambient light directly on the screen. Avoid adverse illumination on the screen from direct sunlight or fluorescent lighting fixtures.

The use of controlled ambient lighting, such as incandescent spot light or a dimmer, is recommended for proper room illumination. Where possible, care should also be taken to ensure that the floors and walls of the room in which the projector is to be installed are non-reflecting, dark surfaces. Brighter surfaces will tend to reflect and diffuse the ambient light and hence reduce the contrast of the projected image on the screen.

2 LOCATION AND FUNCTION OF CONTROLS

REAR PANEL TERMINOLOGY

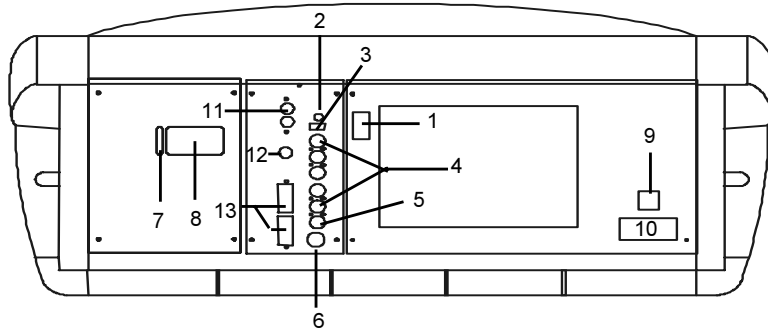

1. **Communication port** (800 peripherals)
 - allows communication between the RCVDs switcher and the projector.
 - allows connection of a remote IR receiver unit to the projector.
2. **IR Remote** - Remote input for wired remote control
3. **IR sensor** - Receiver for control signals transmitted from the RCU.
4. **RGB-S IN or (R-Y)Y(B-Y)-S IN (5 x BNC connector) :**

RGB-S in : allows a character generator, microcomputer, video camera, etc. having analog RGB output to be connected to the projector.

Line inputs : - signals RED-GREEN-BLUE
 - COMPOSITE sync. signal or Hor. sync
 - Vertical sync
5. **VIDEO IN (Composite video, 1 x BNC)** connector allows a video tape recorder, video camera, color receiver/monitor, etc. having video line output to be connected to the projector.
6. **S-VIDEO IN:** Separated Y/C (luma-chroma) signal inputs and outputs for higher quality playback of Super VHS signals. (**4-pin S-VIDEO connector**).
7. **Auto diagnosis display**
 - STD BY / NORMAL
 - PAUSE
 - COINCIDENCE
 - EHT HOLD DOWN
 - IR CODE RXD
8. **Local key Pad**
9. **Power (Mains) Switch:** Depending on the software set-up of the projector during installation, the projector switches to 'standby' or to 'operational mode'. If in standby, the standby led in the auto diagnosis display lights up.
10. **Power (Mains) input:** Connect the supplied ac power (mains) cord here and to the wall outlet.
11. **Audio Output :** Only if the Tuner option is installed. Audio out to be connected to audio amplifier.
12. **RF input :** Only if the Tuner option is installed. Input for RF signals from a TV cable network or TV antenna.
13. **RS 232 :** Allows connection to the serial port of a Computer for controlling the projector.

Front Panel Terminology

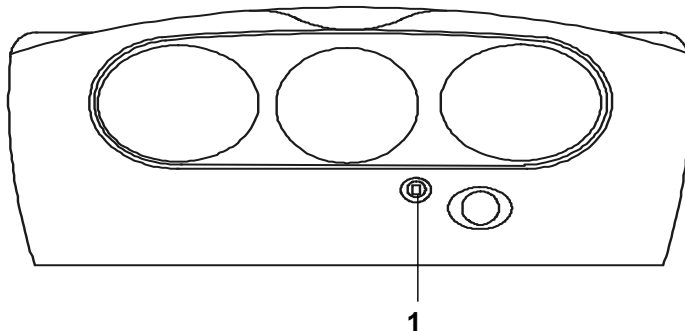

1. **IR SENSOR :** Receiver for control signals transmitted from the RCU.

Control panel terminology

a. The local keypad

The local keypad is at the rear side of the projector.

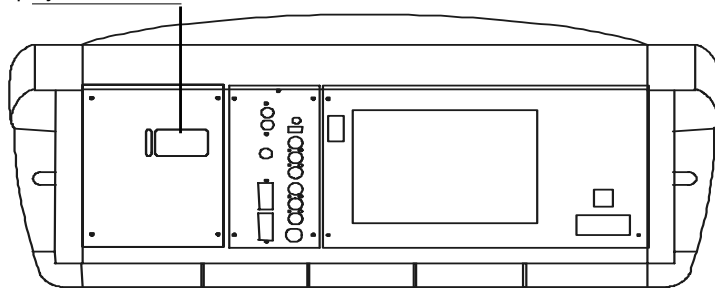

b. RCU control panel terminology

This remote control includes a battery powered infrared (IR) transmitter that allows the user to control the projector remotely. This remote control is used for source selection, control, adaptation and set-up. It includes automatic storing of :

- picture controls (Brightness, Sharpness,...)
- picture geometry adjustments
- convergence adjustments

Other functions of the remote control are:

- switching between standby and operational modes
- switching to "pause" (blanked picture, full power for immediate restarting)
- direct access to all connected sources
- variable adjustment speed : when pushing continuously on the arrow keys or the picture keys, the adjustment will be executed in an accelerated fashion.

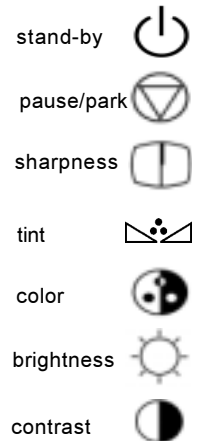
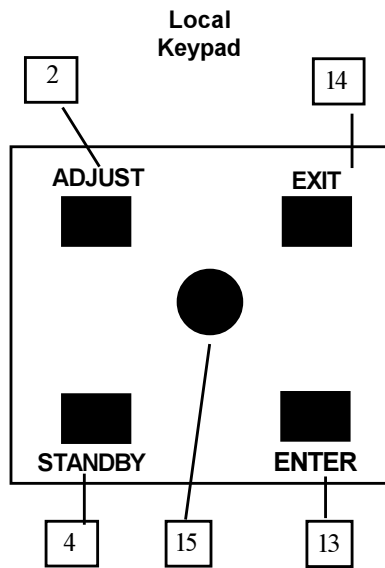
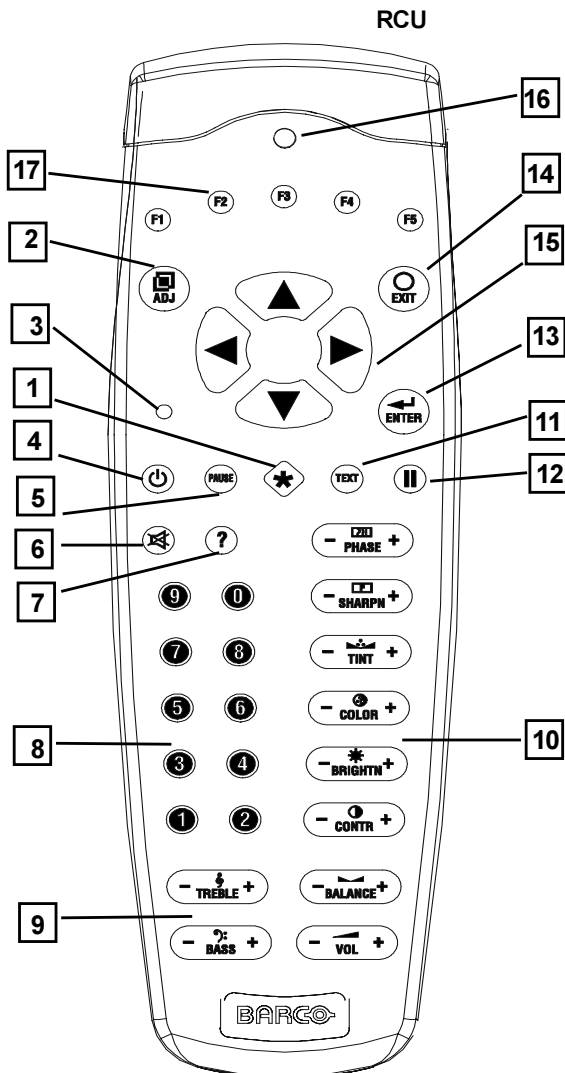

- 1 Star Key** : When a RF-tuner is built in (option), this is used to toggle between Video and tuner signal.
- 2 ADJ.** : adjust key, to enter or exit the adjustment mode.
- 3 Address key (sunk key)** : to enter the address of the projector (between 0 and 9). Press the address key, followed by pressing one digit button between 0 and 9.
- 4 STBY** : stand by button : - to initiate remote power up operation
- to stop projection without main power off.
- 5 Pause** : to blank the image, press PAUSE. The image disappears but full power is retained for immediate restarting.
- 6 Mute** : The picture stays while the audio is turned off. The power for the amplifiers stays.
- 7 Help** : On line help information (not yet available)
- 8 Digit buttons** : Direct input selection
- 9 Audio control** : use these buttons to obtain the desired level (see also 'Controlling') for each audio function
- 10 Picture controls** : use these buttons to obtain the desired level (see also 'Controlling') for each picture function.
- 11 TEXT** : During Video or RGB operations : when adjusting one of the image controls, the displayed bar scale can be removed by pressing 'TEXT' key first. To re-display the bar scale on the screen, press 'TEXT' key again. 'TEXT' key is only active in operational mode. When 'TEXT' key is off, no warning message will be displayed. When in Tuner mode : this key is used to activate teletext.
- 12 Freeze** : When in teletext mode, (only when the tuner options installed) this key is used to freeze the actual page.
- 13 Enter** : to start up the adjustment mode or to confirm an adjustment or selection in the adjustment mode.
- 14 Exit** : to leave the adjustment mode or to go back to the previous menu when in the adjustment mode.
- 15 Control keys** : to make menu selections when in the adjustment mode. Also allows to increment or decrement an adjustment in the adjustment mode.
 - ▲ = up arrow in the menus.
 - ▼ = down arrow in the menu.
 - ▶ = right arrow in the menus.
 - ◀ = left arrow in the menus.
- 16 RC operating indication** : lights up when a button on the remote control is pressed. (This is a visual indicator to check the operation of the remote control).
- 17 Function keys** : Direct access keys for certain menu functions.

3

CONNECTIONS

Power (mains) cord connection

Use the supplied power cord to connect your projector to the wall outlet. Plug the female power connector into the male connector on the rear of the projector.

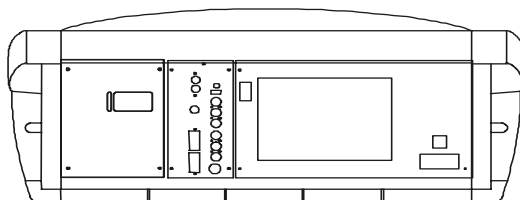

120/230v
4/2.5A
60/50 Hz
300 W

Switching on/off

The projector is switched ON and OFF using the power (mains) switch ON/OFF.

Pressed : ON
Not pressed : OFF

The projector can start now in the 'operational mode' (image displayed) or in the 'stand by mode', depending on the software setting in the service menu of the projector. This is done during installation by a qualified technician. If you want to change this start up mode, call a qualified technician.

Stand by indication lamp :

No light up : Projector in operational mode
Red : Projector is in stand by.
Leds on the rear plate of the projector

- STDBY/NORMAL
- PAUSE
- COINCIDENCE
- EHT HOLDDOWN
- IR RECVD

Signal input connection to the projector :

- Composite Video
- S-Video
- RGSB or RGsB
- YsUV or YUVs [component input]

Source No	Projector input	Press digit
1	Comp. Video	1
2	S-Video*	2
3	Tuner	4
4	RGSB	5
5	RGBs	6
6	YUV	6

* Input signal Y/C (luma/chroma)

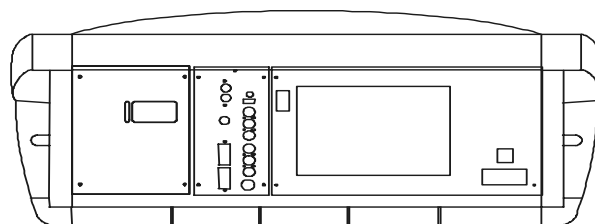

Connecting a Composite Video source

Composite video signals from a VCR, OFF air signal, decoder, etc.

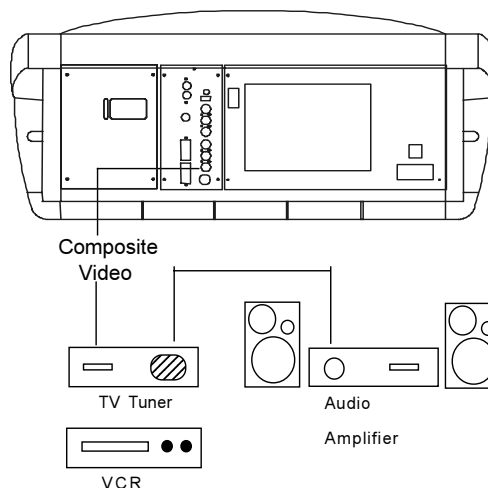

Video input selection

- a. with the RCU : press digit 1
 OR
- b. with the local keypad
 - press **ADJUST** key, the General access menu is displayed on the screen
 - use the control keys to highlight 1
 - press **ENTER** to select the highlighted source

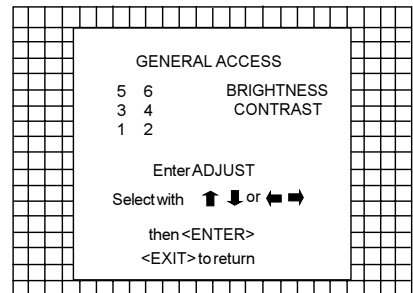

Connecting a S-Video to port 2.

Separate Y-luma/C-chroma signals for higher quality playback of S-VHS signals.

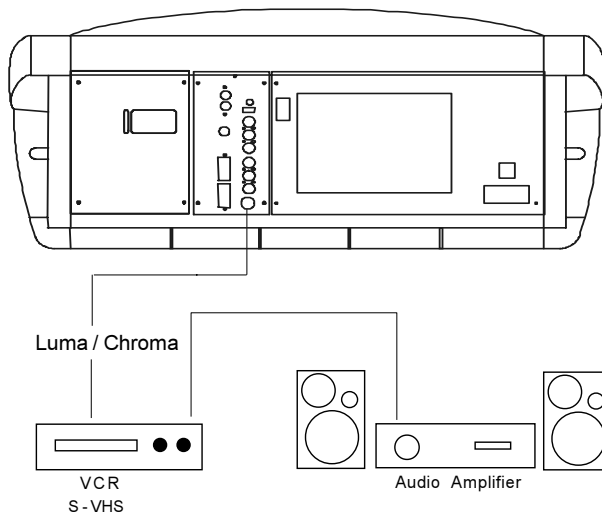

Input selection

- a. with the RCU : press digit 2
 OR
- b. with the local keypad :
 - press **ADJUST** key, the General access menu is displayed on the screen
 - use the control keys to highlight 2
 - press **ENTER** to select the highlighted source.

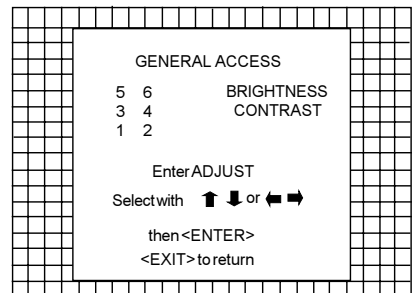

Connecting a RGB Analog source with composite sync.

RGB analog input terminals with composite sync input or with sync on green. The projector detects automatically where the sync signal is located.

Always use an interface when a computer and local monitor have to be connected to the projector. Examples of interfaces which can be applied :

Universal analog interface : **R9826100**

RGBs (or RGSB) input selection

- a. press digit 5 on the RCU
- OR
- b. with the local keypad :
 - press **ADJUST** key, the **GENERAL ACCESS** menu is displayed on the screen
 - use the control keys to highlight 5
 - press **ENTER** to select the highlighted source.

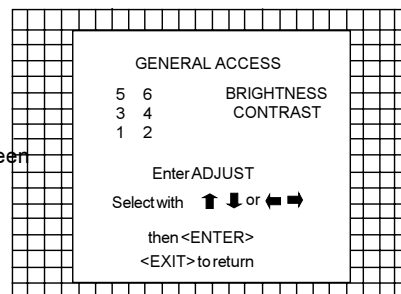

Connecting a Component source

YUV analog input terminals with sync input or with sync on the luminance (Y) input.

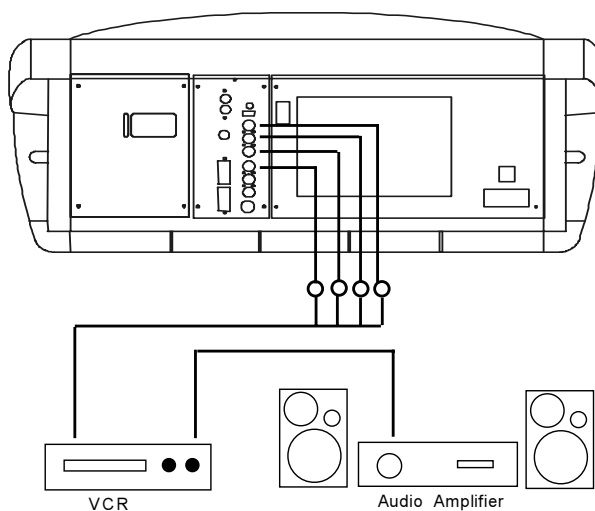

YsUV or YUVS selection

- a. with the RCU : press digit 6 (for YsUV or YUVS)
- b. with the local keypad
 - press **ADJUST** key, the **GENERAL ACCESS** menu is displayed on the screen
 - use the control keys to highlight 6
 - press **ENTER** to select the highlighted source

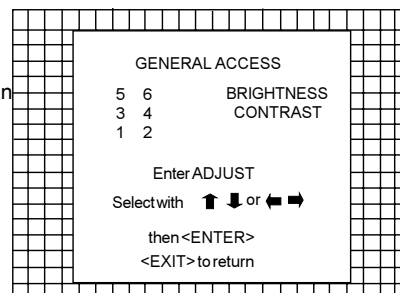

Connecting a RF signal to the projector (optional) :

The projector automatically determines the presence of a tuner.
 Connect the RF signal to the RF input of the projector.
 Connect the audio output to an audio amplifier.

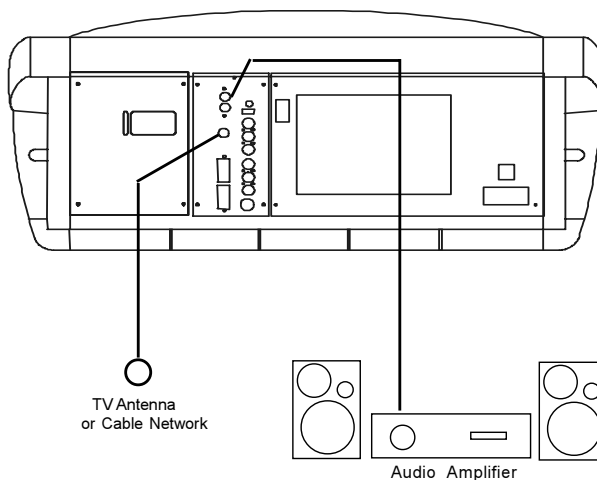

To select the tuner option :

- a. Press the **STAR** key on the RCU to activate the tuner mode
OR
- b. With the local keypad :
 - Press **ADJUST** key to display the **GENERAL ACCESS** menu on the screen.
 - Use the control keys to highlight '**TUNER**'.
 - Press **ENTER** to activate the tuner mode.

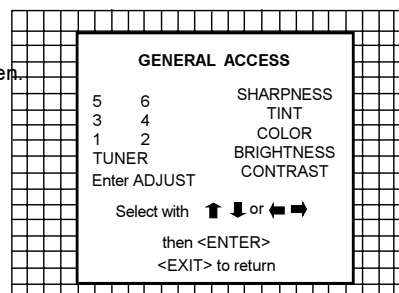

Peripheral equipment

Connecting a RCVDS 05 switcher to the projector

- Up to 10 inputs (20 inputs when video and S-Video) with the RCVDS 05 switcher and up to 90 inputs when 10 RCVDS switchers are linked via the expansion modules.
- Serial communication with the projector.
- Remote control buttons on the RCVDS to control the projector (source selection and analog settings).
- The selected source number will be displayed on a 2 digit display and the selected input modules will be indicated with a LED on the rear.

For more information about the use of the RCVDS 05, consult the Owner's Manual, order No. **R5975765**.

Connecting a VS05 switcher to the projector

The VS05 can switch up to 5 Composite Video sources, 3 S-Video sources and 1 RGB analog or component video source to the projector. In addition, the audio signal from the source can be switched to an audio amplifier. Order No. **R9827890**.

For more information about the use of the VS05, consult the Owner's Manual, Order No. **R5975245**.

Connecting an IR Remote Receiver to the Projector

This infra-red receiver makes it possible to control the projector from another room. There is a communication cable between the IR receiver and the projector or the RCVDS. The infrared control information from the RCU is sent to the IR Remote Receiver. The IR Remote Receiver 800 displays the selected source on a 7-segment display. Order No. **R9827515**.

4

CONTROLLING

CAUTION : Do not display a stationary image with full brightness and contrast for longer than 10 minutes, otherwise you risk damage to the tubes.

Battery installation in the RCU

2 new batteries are delivered inside the plastic bag with the power cord. Before using the RCU, install the batteries. Remove the battery cover on the backside of the remote control by pulling the indicated lever a little to the bottom of the RCU. Lift up the top side of the cover at the same time (fig. 1). Insert the new batteries (AA type or equivalent) in the compartment according to the markings in the compartment, and put the cover back.

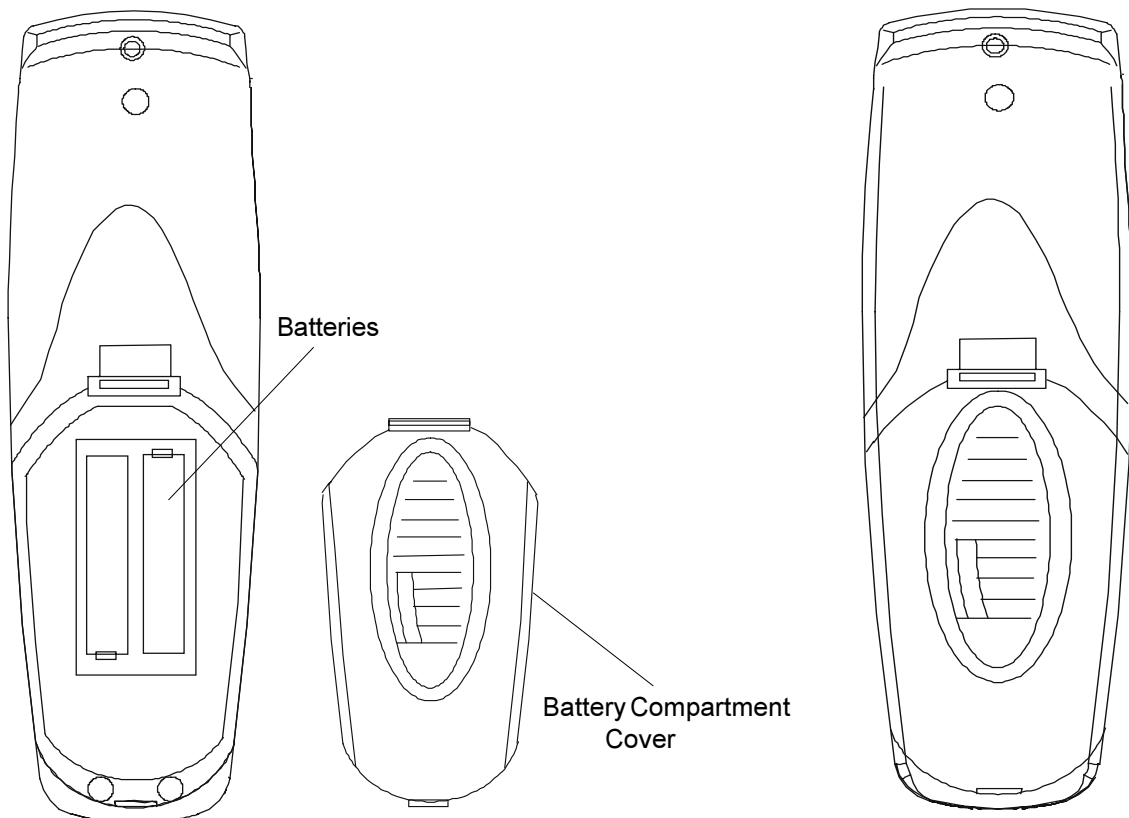

The projector can be controlled with

- a. The RCU
- b. The hardwired RCU (cable not included)
- c. The local keypad.

Controlling the projector with the RCU and the hardwired RCU is the same.

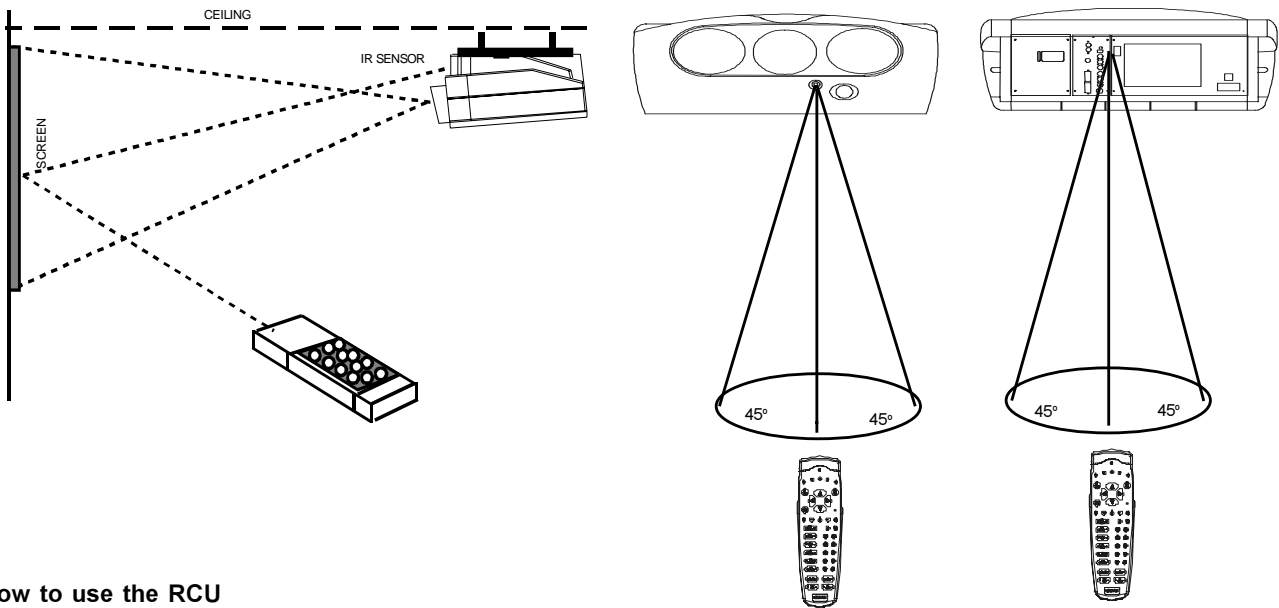

How to use the RCU

- a. Point the front of the RCU towards the reflective screen surface.
- b. Point the front of the RCU towards one of the IR sensors in the projector.

When using the RCU, make sure you are within the effective operating distance (10m or 30 ft. in a straight line). The RCU will not operate properly if strong light strikes the sensor window or if there are obstacles between the RCU and the projector's IR sensor.

- c. RCU used in a hardwired configuration. Plug one end of the remote cable in the connector at the end of the RCU and the other end in the connector on the rear panel of the projector labelled 'REMOTE'.

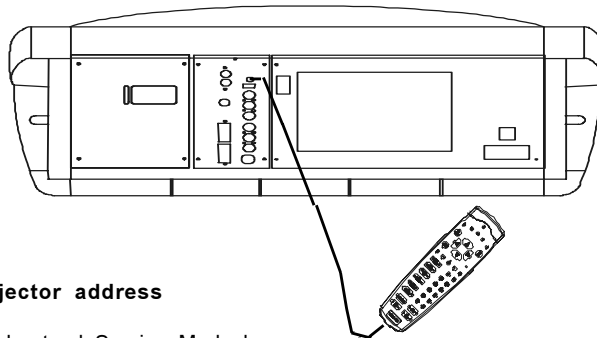

Projector address

- a. **Software setup of the projector address**

See ' Change Projector Address ' in chapter ' Service Mode '. Every projector requires an individual address between 0 and 255, which is set in the service mode. Only projectors with addresses between 0 and 9 can be controlled with the RCU.

- b. **How to control the projector**

The projector's address may be set to any value between 0 and 255. When the address is set, the projector can be controlled with :

- the RCU for addresses between 0 and 9.
- a computer for addresses between 0 and 255.

Note : The projector will respond to a RCU set to an address of 0 regardless of what address is set in the projector.

- c. **Using the RCU**

Before using the RCU, it is necessary to enter the projector address into the RCU. The projector with the corresponding address will respond to that RCU.

How to display the projector address.

Press the ADDRESS key (recessed key on the RCU) with a pencil. The projector's address will be displayed in a 'Text box'.

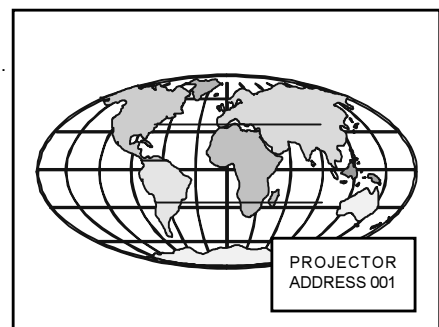

How to program an address into the RCU

To continue using the RCU, it is necessary to enter the address shown in the 'Text Box' with the digit keys on the RCU. For example, if the displayed address is ' 003 ', press 3 on the RCU.

Input selection

Source No	Projector input	Press digit
1	Comp. Video	1
2	S-Video	2
3	Tuner	4
4	RGsB	5
5	RGBs	6
6	YUV	

Two possible ways of selecting an input :

- a. with the digit keys on the RCU
- b. with the local keypad

Press first the **ADJUST** key to display the **GENERAL ACCESS** menu. Use the control keys to highlight the desired number. Press **ENTER** to confirm your selection.

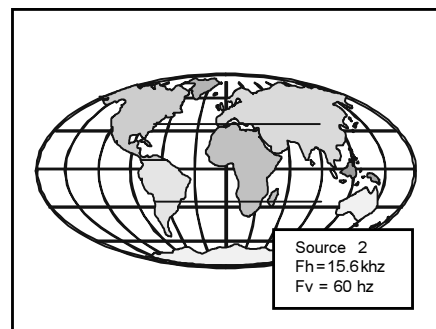

When a valid and connected source is selected, information about that source will be displayed in a 'Text Box' on the screen. This information includes :

- Source Number
- Horizontal scan rate
- Vertical scan rate

When the entry is an invalid source number, a warning appears on screen

Input not available

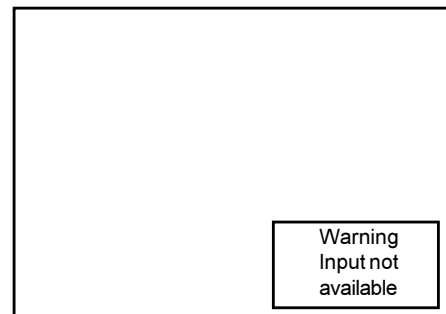

When a valid source number is selected, the projector will display this source or it will wait until the source becomes available. A message **Source not available** will be displayed for a short time.

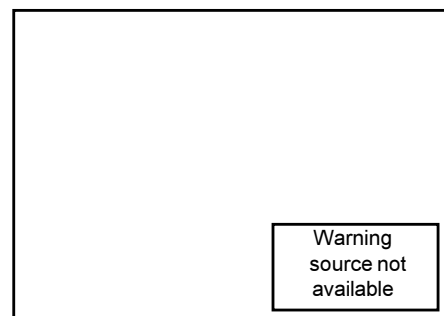

Picture controls

The picture controls can be adjusted with :

- a. The RCU. The keys are located on the right side of the RCU and marked with the name of the control and an icon. When a picture control is pressed, a Text Box with a bar scale and the control name, e.g. ' Brightness ' appears on the screen (only if TEXT is ON). The length of the bar scale indicates the current setting of this control. The bar scale changes as the left or right arrow keys on the RCU are pressed.

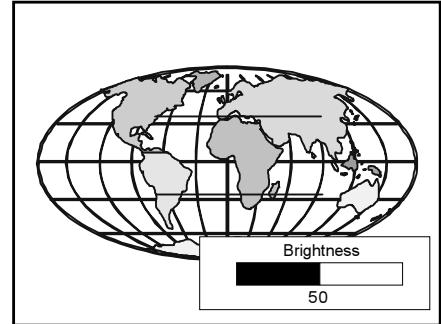

- b. The local keypad.
 - Only **BRIGHTNESS** and **CONTRAST** are available in the **GENERAL ACCESS** Menu.
 - Press the **ADJUST** key to display the **GENERAL ACCESS** Menu.
 - Use the arrow keys to highlight the desired control and press **ENTER** to select.

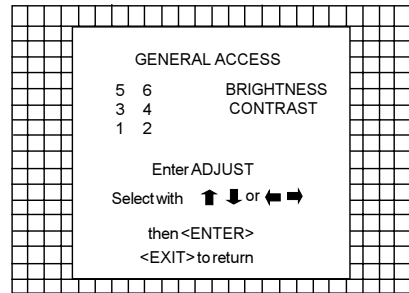

Brightness Control

A correct **BRIGHTNESS** setting is important for good image reproduction. Adjust the brightness with the + and - keys until the darkest parts of the picture appear black.

A bar scale gives a visual indication on the screen of the brightness setting while pressing the above mentioned keys. If the bar scale is not visible on the screen, press the **TEXT** key once and retry the brightness keys.

Contrast control

A correct **CONTRAST** setting is important for good image reproduction. Adjust the contrast to the level you prefer, according to room lighting conditions.

A bar scale gives a visual indication on the screen, of the current contrast setting while pressing the + or - keys. If the bar scale is not visible on the screen, press the **TEXT** key once and retry the contrast key.

Color Saturation control

Color saturation is only active for Video and S - Video. Adjusts the color intensity of the picture. Adjust the color saturation by pressing the + or - keys on the RCU.

A bar scale gives a visual indication on the screen, of the current color setting while pressing the + or - keys. If the bar scale is not visible on the screen, press the **TEXT** key once and retry the color key.

Tint Control

Tint is only active for Video and S-Video. Tint control is only effective when using the NTSC 4.43 or NTSC 3.58 system.

A bar scale gives a visual indication on the screen of the current tint setting while pressing the + or - keys on the RCU. If the bar scale is not visible on the screen, press the **TEXT** key once and retry the tint key.

Sharpness control

The sharpness control is only active for Video and S-Video.

A bar scale gives a visual indication on screen of the current sharpness setting, while pressing the + or - keys on the RCU. If the bar scale is not visible on screen, press the **TEXT** key and retry the sharpness key.

The Pause key

When the pause key is pressed, the projection is stopped but the projector remains at full power-on for immediate restart of projection.

To restart the projection :

- Press the PAUSE key
- Select a source number.

Sound control with the RCU (optional)

Only available when the Tuner is installed.

The following sound control keys are available on the RCU :

Volume control

Bass control

Treble control

Balance control

There is a bar scale associated with each of these keys, in the same way as for the Picture control keys.

Mute

The **Mute** key stops the sound when pressed.

Pressing a second time restarts the sound.

5

START UP OF THE ADJUSTMENT MODE

Adjustment mode

All picture geometry and convergence adjustments are made while in the **ADJUSTMENT MODE**.

There are two possible ways to enter the **ADJUSTMENT MODE** :

a. Using the local keypad :

Press the **ADJUST** key. The projector displays the **GENERAL ACCESS** menu.
Highlight **ENTER ADJUST** and press **ENTER** to display the **ADJUSTMENT MODE**.

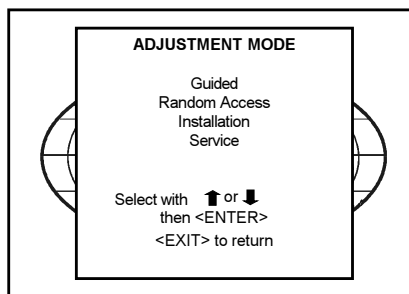

While in the Adjustment Mode, the arrow keys (RCU) or the control keys (local keypad) can be used to make menu selections and also horizontal and vertical adjustments. The **ENTER** and **EXIT** keys can be used to move forward and backwards thru the menu structure. The **ADJUST** key can be used to terminate the Adjustment Mode.

There are four possible paths to follow in the Adjustment Mode :

- Guided** - Guided should be selected if the user intends to perform a complete alignment of the projected image. All the necessary geometry and convergence adjustments are made in a predetermined sequence.
- Random Access** - Random Access should be selected if the user intends to make only a few adjustments.
- Installation** - Installation should be selected if the projector has been relocated and/or a different screen size is desired. When selecting 'Installation', the user will be warned to call a qualified technician to perform the installation procedure.
- Service** - Service should be selected if the user wants to delete or modify memory blocks, change password or apply information. While in Guided or Random Access adjustment mode, the user may use an external source, an internally generated genlocked pattern or an internally generated multifrequency cross hatch pattern, as a set-up pattern.

Some items in the Adjustment mode are password protected. While selecting such an item, the projector asks you to enter your password. (Password protection is only available when the Password strap on the controller module is in the ON position. Contact a BARCO authorized technician when no password is requested during the adjustment procedure and password protection is desired.)

Your password contains 4 digits.

b. Using the RCU :

Press the **ADJUST** key.
The projector displays the main menu. Highlight **SERVICE** menu and press **ENTER** twice, to display the Adjustment Mode.

Enter the digits with the numeric keys on the RCU.

Example : 2 3 1 9

For each digit entered, a ' x ' appears on the screen under the **ENTER PASSWORD TEXT**.

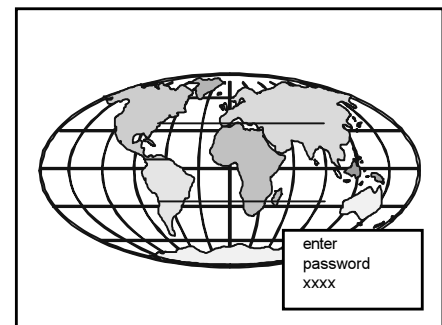

When your password is correct, you get access to the Adjustment Mode.

When the password is incorrect, the message **WRONG PASSWORD** will be displayed. The projector stays on the previously selected item.

Factory programmed password : **0000**

6

RANDOM ACCESS ADJUSTMENT MODE

Starting up the Random Access Adjustment Mode.

Highlight 'RANDOM ACCESS' in the Adjustment Mode Menu with the arrow keys on the RCU, and then press 'ENTER'.

Some items in the Random Access mode are password protected (when the password function is enabled). Enter your password to continue. All other password protected items are now also available if you stay in the adjustment mode.

ENTER continues to setup Pattern Selection.
EXIT returns to previous menu.

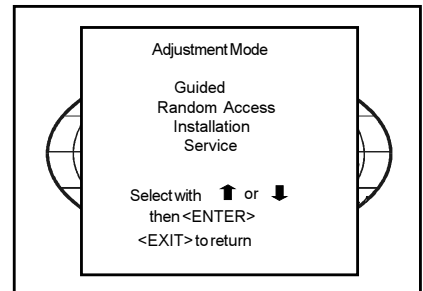

Overview of Random Access Adjustment mode.

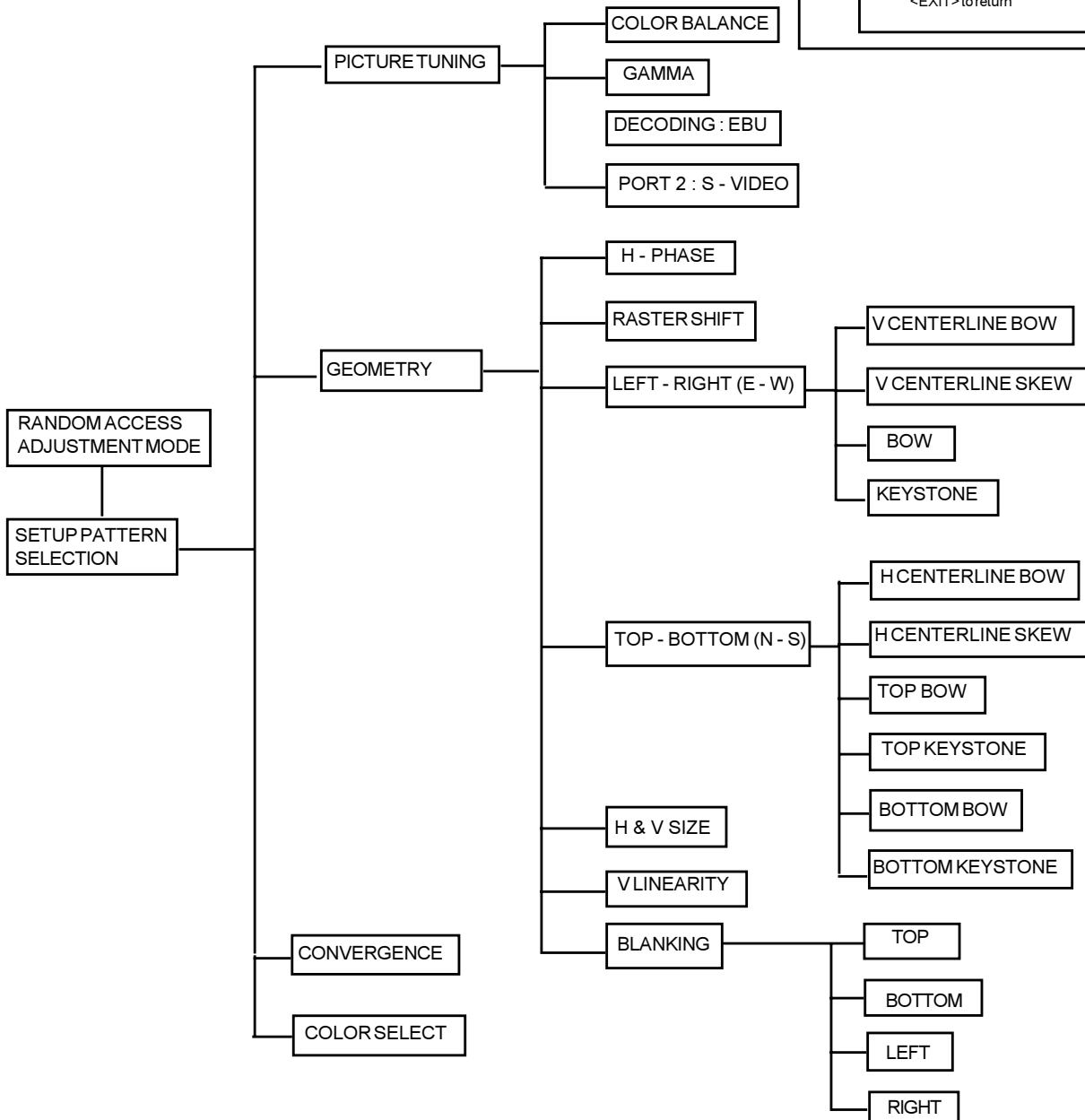

Selecting a Setup Pattern

If an external source is connected to the projector, this menu will be displayed. Highlight the desired setup pattern with the arrow keys on the RCU and press ' Enter ' .

- Genlocked pattern** : internally generated cross hatch pattern, locked to the external source.
- Internal pattern** : internally generated cross hatch pattern.
(no external source required).

ENTER continues to Random Access Adjustment Mode
EXIT returns to previous Menu
ADJUST returns to operational mode

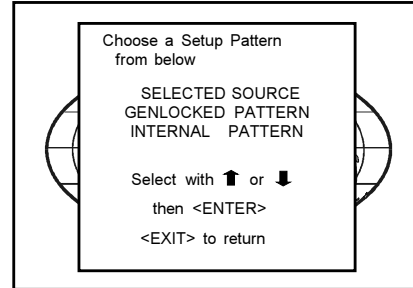

If no external source is connected to the projector, the internal cross hatch pattern menu will be displayed.

Internal Cross Hatch Pattern

The internal # pattern menu will be displayed if the internal cross hatch pattern has been selected or if no source is connected to the projector.

Random Access Adjustment mode selection menu.

This is the main menu for the Random Access Adjustment mode. Through this menu, the following adjustments are accessible :

- Picture Tuning
 - Color Balance
 - Gamma
 - Decoding : EBU or IRE
- Geometry
- Convergence
- Color Select

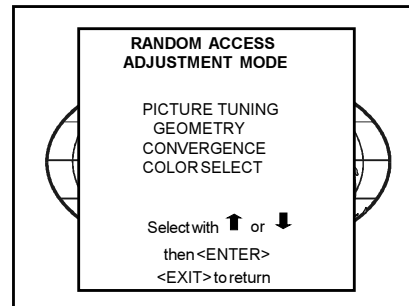

Picture Tuning

Highlight ' Picture Tuning ' with the arrow keys and press ' ENTER '. The Picture Tuning Menu will be displayed. Depending on the source, the following items will be displayed :

- Color Balance
- Gamma
- Decoding : EBU or IRE
- Port 2 : S-Video or Video

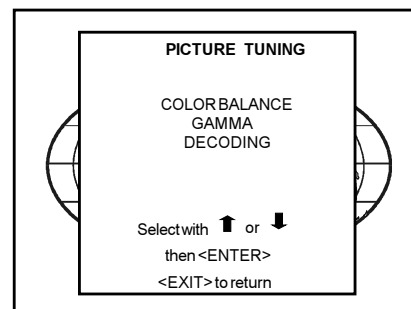

Color Balance

The Color Balance function is used to select or adjust the color temperature of white used by the projector. The color balance can be adjusted in two different ways :

- fixed color balance. You have the choice between 3200K (reddish), 4900K, 6500K (white), or 9300K (bluish).
- custom white and black balance.

Fixed Color Balance :

Highlight one of the 4 preprogrammed values with the arrow keys and press 'ENTER' to apply.

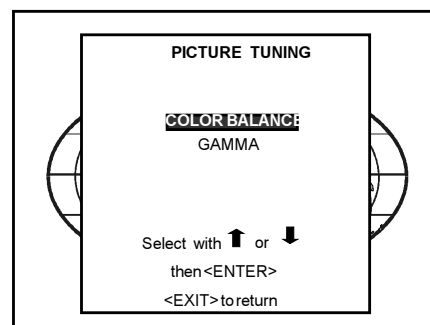

Custom Color Balance :

Select Custom White balance with the arrow keys and press 'ENTER' to start the adjustment.

Use the up and down arrow keys to adjust the RED gain or the left and right arrow keys to adjust the BLUE gain. A bar scale indicates the amount of adjustment. Same for GREEN.

Select Custom Black balance with the arrow keys and press Enter to start the adjustment.

Use the up and down arrow keys for RED or left and right arrow keys for the BLUE cutoff. Same for Green.

When the color balance is adjusted, press Exit to return to the Picture Tuning Menu.

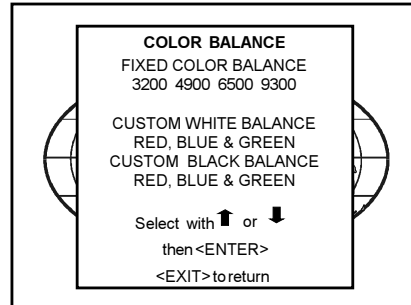

Gamma

The GAMMA adjust function acts on the luminance content of the image. It has a non-linear amplification characteristic. At minimum Gamma (< 1), the lower parts of the signal are amplified with higher gain.

ENTER will select the GAMMA function
EXIT will return to the Random Access Adjustment Menu

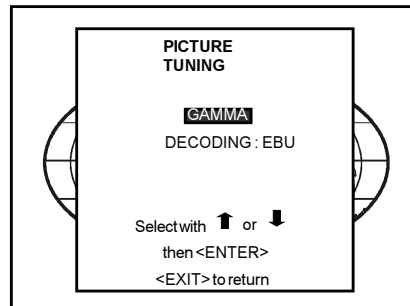

Decoding

Only for NTSC signals.

Highlight 'DECODING' with the arrow keys. Pressing ENTER will toggle between EBU and IRE standards.

ENTER will toggle Decoding between EBU and IRE
EXIT will return to the Random Access Adjustment Menu

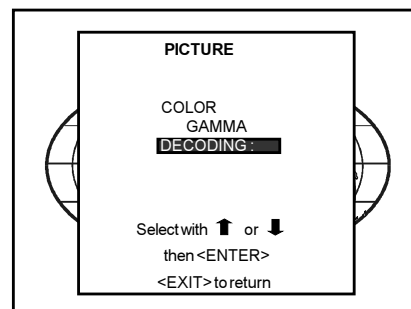

PORT 2 : S-Video

Port 2 can be used as a Video or S-Video input.

When connected to a S-Video this menu will appear automatically. Pressing enter will toggle between S-Video & Video.

Toggling this to video will give a monochrome picture. Toggling to S-Video will again give a color picture.

ENTER will toggle PORT 2 between S-Video & Video
EXIT will return to the Random Access Adjustment Menu

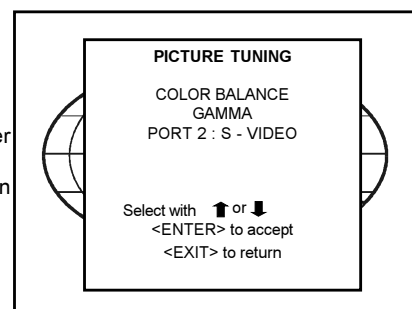

Color Select

Highlight 'COLOR SELECT' using the arrow keys and press 'ENTER' to display the color select menu.

Enter continues to the color select menu
Exit will return to the previous menu
Adjust returns to operational mode

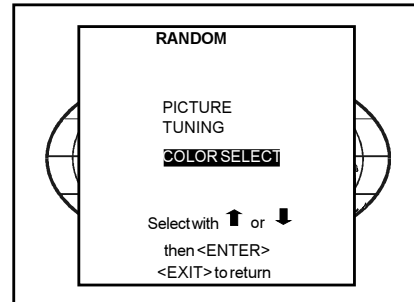

Use the arrow keys to highlight a color (CRT) or combination of colors to display the image in that specific color. To select a new color, press **Enter**. The color selection menu appears again on the screen. To terminate the color selection process, press **Exit**.

Enter continues with the selected color or color combination.
Exit returns to the Random Access Adjustment main menu.

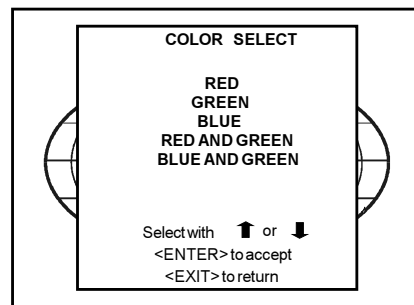

Geometry Adjustments

The geometry adjustments have to be done only on the green image. These adjustments are automatically implemented for the other color images.

Highlight 'GEOMETRY' in the Random Access Adjustment menu, using the arrow keys and press **ENTER** to display the Geometry menu.

Enter will display the Geometry menu.
Exit will return to the previous menu.
Adjust returns to operational mode.

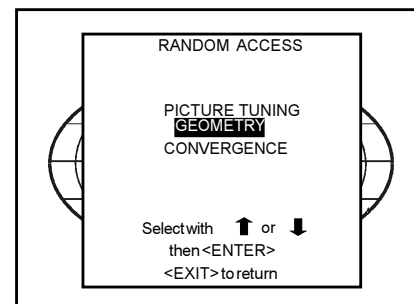

Within the Geometry Adjustment menu, the following adjustments are available :

- Horizontal Phase (not for internal # pattern)
- Raster shift
- Left - Right (E-W) corrections
- Top - Bottom (N-S) corrections
- Horizontal size
- Vertical linearity
- Vertical size
- Blanking

The convergence corrections are disabled during geometry adjustments.

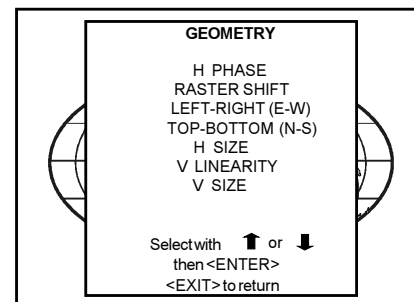

Horizontal Phase Adjustment

Highlight H PHASE using the arrow keys and then press ENTER.

Note : No Horizontal Phase adjustment is available on the internal # pattern.

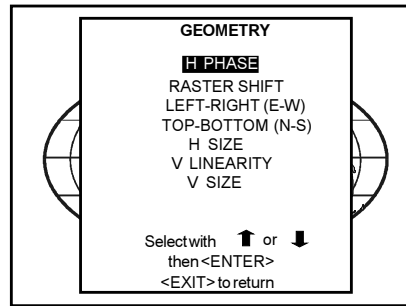

For external sources :

If the raster shift is correctly adjusted, the H Phase text box is projected in the lower center of the raster. At that moment, the '><' icon indicates the center of the raster.

Adjust the H phase control until the middle of the projected image is equal with the center of the '><' icon.

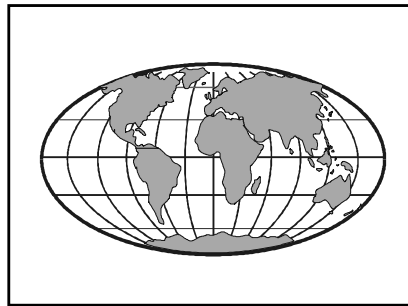

Note : If the genlocked pattern was selected, the external source will be displayed.

A bar scale and a value (between 0 and 100) on the screen give a visual indication of the horizontal phase adjustment.

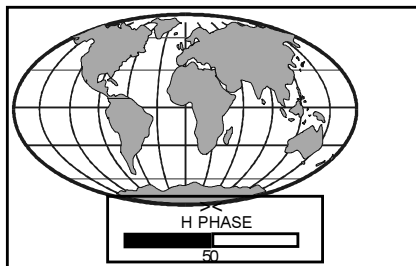

Use Right arrow to correct

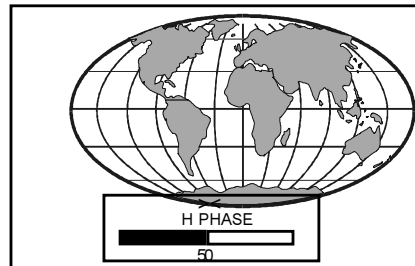

Use Left arrow to correct

ENTER continues to geometry menu

Raster Shift Adjustment

The green raster must be centered both horizontally and vertically on the center of the CRT surface. To center the green raster, look into the green lens and use the arrow keys on the RCU to move the raster.

CAUTION :

It is necessary to look into the lenses to perform these adjustments. To avoid eye discomfort while looking into the lenses, reduce the contrast and gradually increase the brightness level until the raster becomes visible on the face of the CRT.

ENTER will select green raster shift adjustment
EXIT returns to Random Access adjustment mode menu

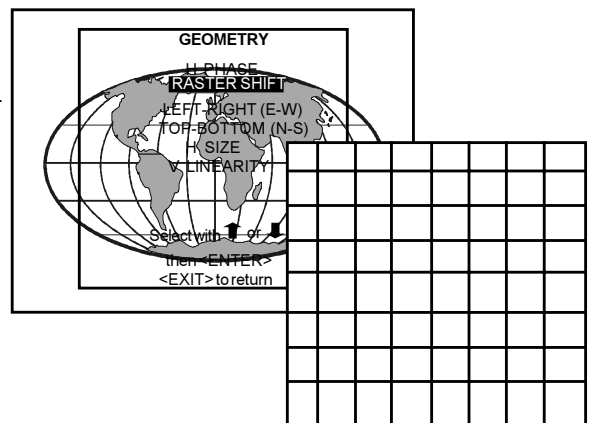

WARNING : In order to ensure maximum CRT longevity and to avoid CRT damage, do not shift the raster outside the phosphor area of the CRT.

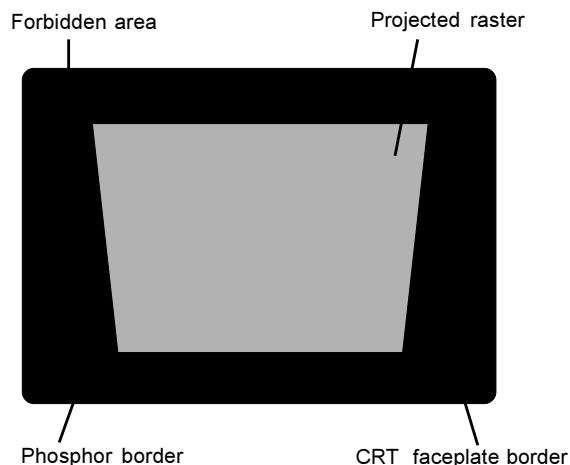

To start the adjustment, use the arrow keys to highlight Raster Shift and press Enter to display the green raster on the CRT.

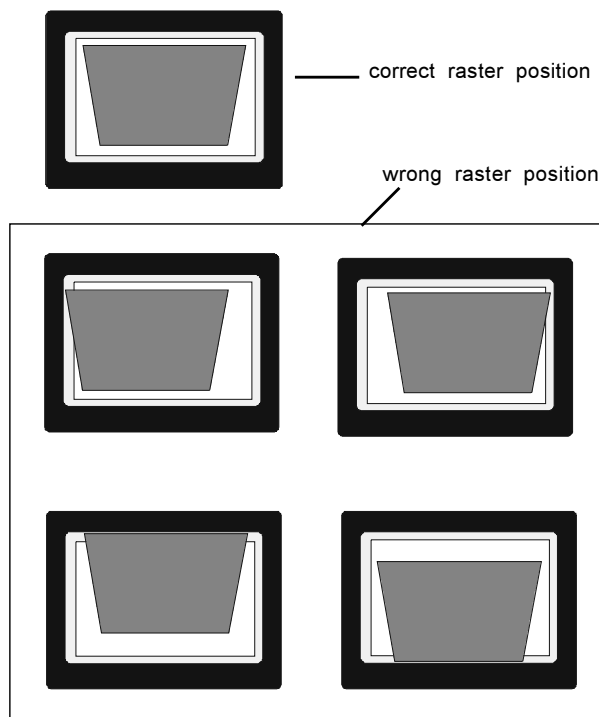

Press **EXIT** to return to the Geometry menu.

Left - Right (East-West) Adjustments

Left - right and center adjustments affect only the vertical lines of the projected image.

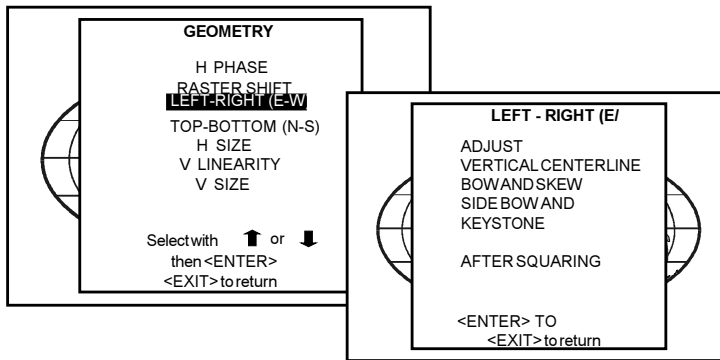

To start up the left - right and center adjustments, follow the next procedure :
Use the arrow keys to highlight **Left-Right (E-W)** on the Geometry menu and then press **ENTER** .

ENTER will select Left-Right adjustment menu
EXIT returns to the Random Access Adjustment main menu
ADJUST returns to operational mode

Only the Green image is displayed while making left-right adjustments. The Red and Blue images will automatically be corrected in the same manner. Convergence corrections are automatically disabled for the duration of these adjustments.

The following adjustments can be done :

- vertical centerline bow
- vertical centerline skew.
- side keystone (left and right)
- side bow (left and right).

All adjustments are indicated on the screen with the function name, a bar scale and a value between 0 and 100.

Vertical Centerline Bow

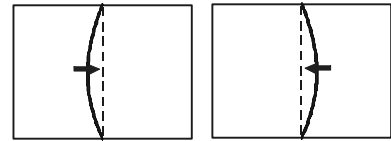

Corrects for curvature of the vertical lines in the middle of the image

Vertical Centerline Skew

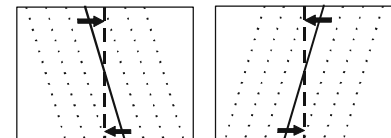

Corrects for the tilting of the vertical lines in the middle of the image

Side Bow

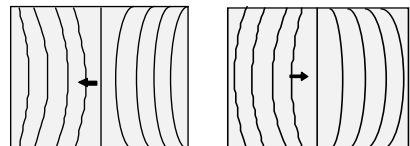

Corrects for the curvature of the vertical lines at the sides of the image

Side Keystone

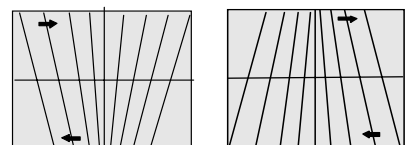

Corrects for the tilting of the vertical lines at the sides of the image

Top-Bottom (North-South) Adjustments

Top-Bottom and center adjustments affect only the horizontal lines of the projected image. To start up the Top-Bottom and center adjustments, follow the next procedure :

Using the arrow keys, highlight **Top-Bottom (N/S)** in the Geometry menu and then press **ENTER**.

Only the green image is displayed while making Top-Bottom adjustments. The red and blue images will automatically be corrected in the same manner. Convergence corrections are automatically disabled for the duration of these adjustments.

The following adjustments can be done :

- Horizontal centerline Bow.
- Horizontal centerline Skew.
- Top Bow.
- Top Keystone.
- Bottom Bow.
- Bottom Keystone.

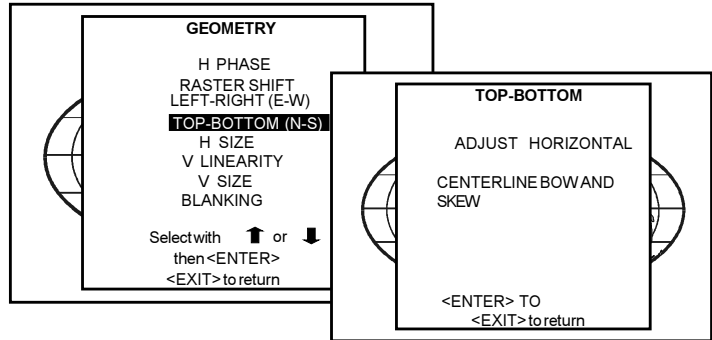

All adjustments are indicated on the screen with the function name, a bar scale and a value between 0 and 100.

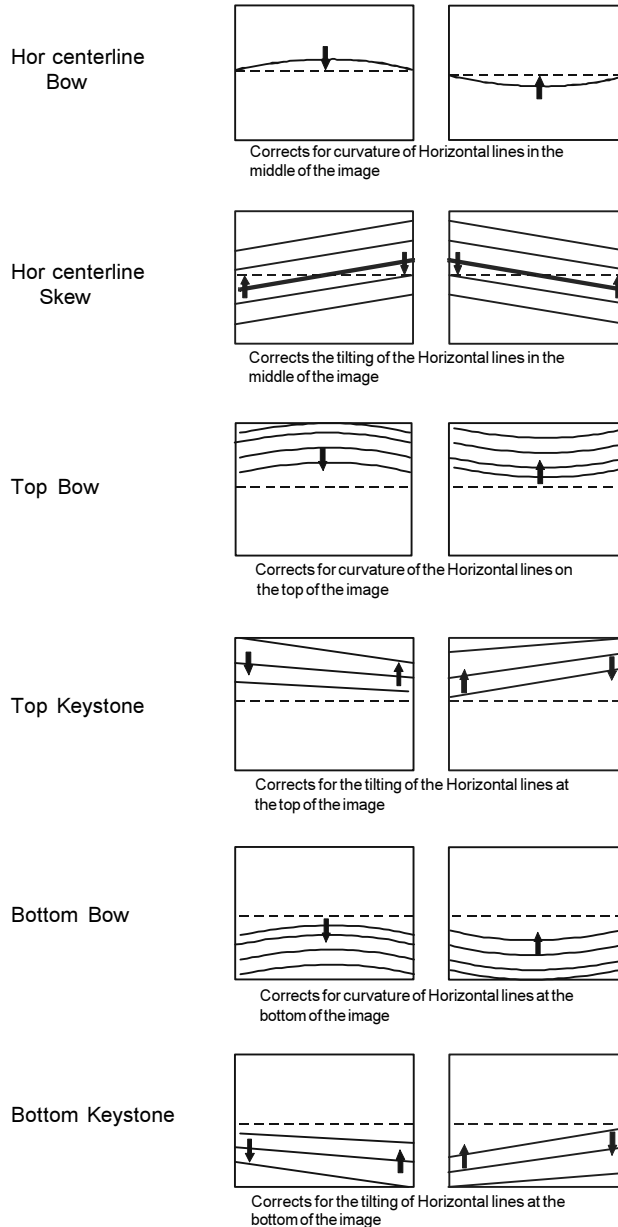

Horizontal Size Adjustment

Use the arrow keys to highlight **H Size** in the Geometry menu and then press **ENTER**.

ENTER will select H Size adjustment
EXIT returns to Random Access adjustment menu.
ADJUST returns to operational mode.

GEOMETRY

H PHASE
 RASTER SHIFT
 LEFT-RIGHT (E-W)
 TOP-BOTTOM (N-S)
H SIZE
 V LINEARITY
 V SIZE

Select with ↑ or ↓
 then <ENTER>
 <EXIT> to return

Adjust the horizontal size by using the left and right arrow keys until the exact horizontal size is obtained.

Note :

- ⊗ if the internal # pattern was selected, the pattern remains on the screen.
- ⊗ if the genlocked pattern was selected, the external source will be displayed.

A bar scale and a numeric indicator help to adjust the horizontal size.

Hint : In order to avoid loss of resolution in the projected image and to ensure maximum CRT life, do not use an excessively small horizontal size setting.

EXIT will return to the Geometry menu.

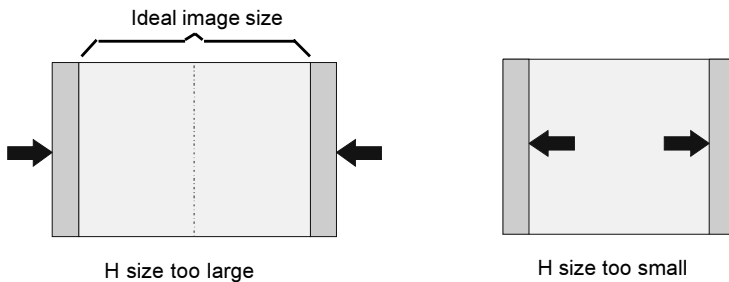

Vertical Linearity Adjustment

The vertical linearity adjustment function corrects for vertical nonlinearities, which extend from the center of the image to the top and bottom.

Use the arrow keys to highlight **V Linearity** in the Geometry menu and then press **ENTER**.

Adjust the vertical linearity with the left and right arrow keys until the distances between the horizontal lines of the setup pattern are equal at top and bottom.

ENTER selects vertical linearity adjustment.
EXIT returns to Random Access Adjustment menu.
ADJUST returns to operational mode.

EXIT will return to Geometry menu.

GEOMETRY

H PHASE
 RASTER SHIFT
 LEFT-RIGHT (E-W)
 TOP-BOTTOM (N-S)
 H SIZE
V LINEARITY
 V SIZE

Select with ↑ or ↓
 then <ENTER>
 <EXIT> to return

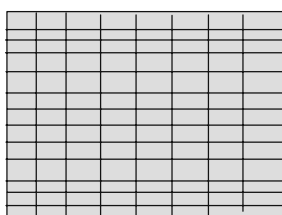

Vertical Size Adjustment

Use the arrow keys to highlight **V size** in the Geometry menu and then press **ENTER**.

ENTER will select vertical size adjustment
EXIT returns to Random Access Adjustment menu
ADJUST returns to operational mode

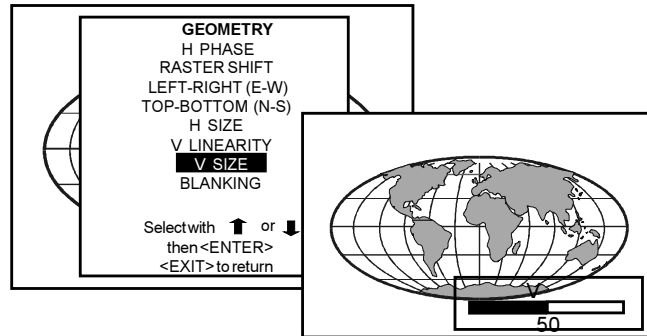

Adjust the vertical size with the up and down arrow keys until the exact image height is obtained.

Note :

- ⊗ if the internal # pattern was selected, the pattern remains on the screen.
- ⊗ if the genlocked pattern was selected, the external source will be displayed.

A bar scale and a numeric indicator on screen help in doing the vertical size adjustment.

Hint : in order to avoid loss of resolution in the projected image and to ensure maximum CRT life, do not use an excessively small horizontal size setting.

EXIT will return to the Geometry menu.

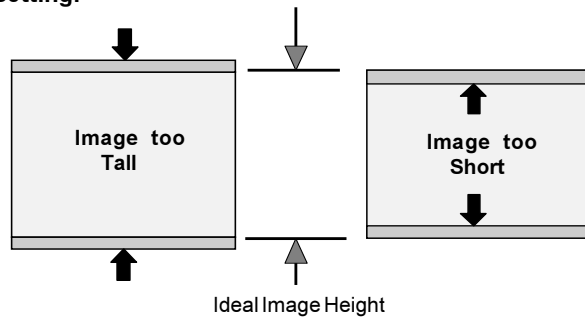

Blanking Adjustments

Blanking adjustments affect only the edges of the projected image and are used to frame the projected image on the screen and to blank out unwanted information or noise. A 0 % on the bar scale indicates no blanking.

To start up the Blanking adjustment, use the following procedure :

Use the arrow keys to highlight **BLANKING** in the Geometry menu and then press **ENTER**.

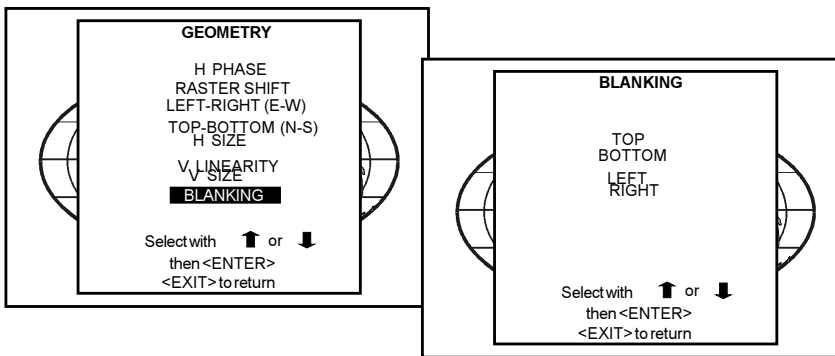

The following corrections are possible :

- Top blanking
- Bottom blanking
- Left blanking
- Right blanking

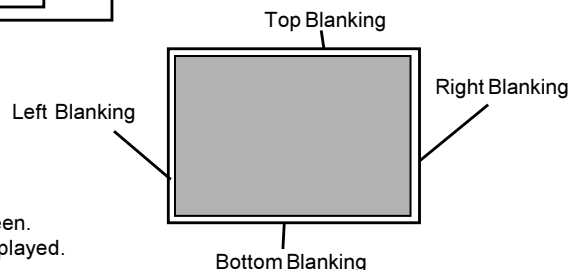

If the internal # pattern was selected, the pattern remains on the screen.
 If the genlocked pattern was selected, the external source will be displayed.

Adjust the blanking alignments until the image is correctly framed or the unwanted information is blanked out. To select a blanking alignment (**Top**, **Bottom**, **Left** or **Right**), use the arrow keys to highlight the function and then press **ENTER**.

EXIT returns to the Blanking menu.

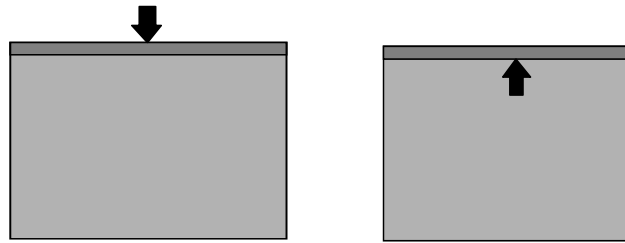

Blanking adjustment at the Top of the image

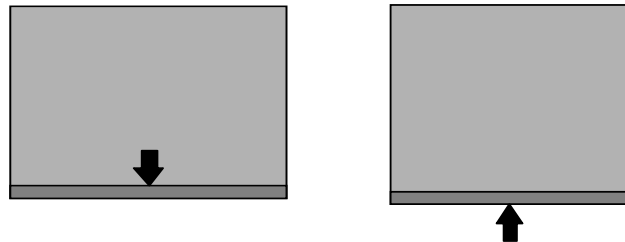

Blanking adjustment at the Bottom of the image

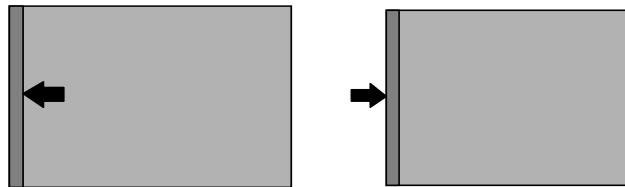

Blanking adjustment at the Left of the image

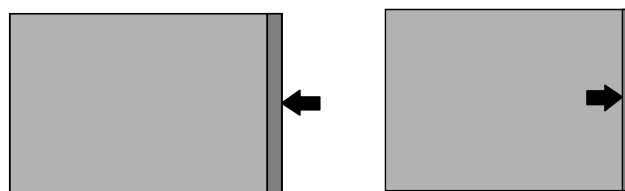

Blanking adjustment at the Right of the image

Convergence Adjustment

Convergence adjustments affect both the horizontal and vertical lines of the setup pattern. These adjustments are performed on the red image while superimposed on the green image and then on the blue image while superimposed on the green image.

Note : the green convergence adjustments can be added as an option. When these are available, start always with 'green only'. This option will also be indicated on the convergence menu.

Highlight first 'Green only' when available by pushing the control disc up or down and press ENTER to display the convergence adjustment menu.

The screen area is divided into 13 areas.

Use the control disc to move the box to the desired zone and then press ENTER to begin the convergence adjustment. Start the convergence adjustment with zone one and continue as mentioned in the diagram hereafter.

Use the control disc to make horizontal or vertical convergence adjustments in the selected zone and then press ENTER to move the box to another zone or EXIT to return to the Convergence menu.

ENTER toggles the control disc between zone selection and zone adjustment .
EXIT returns to convergence menu

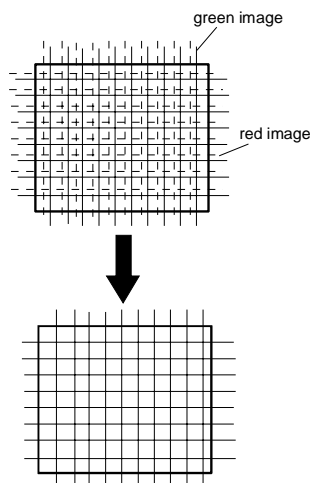
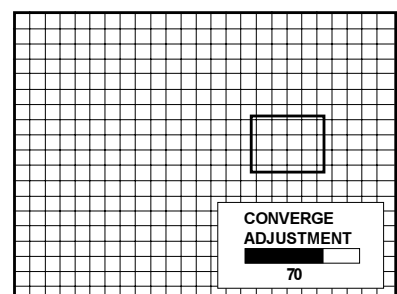
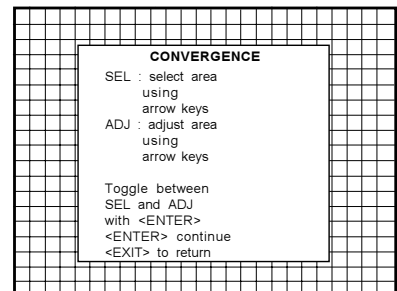
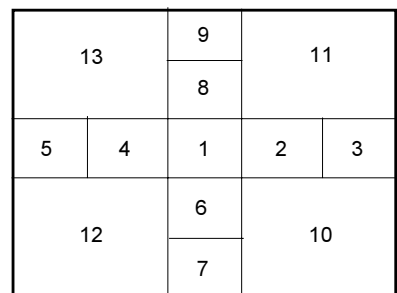
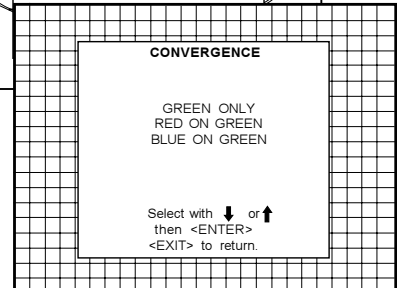
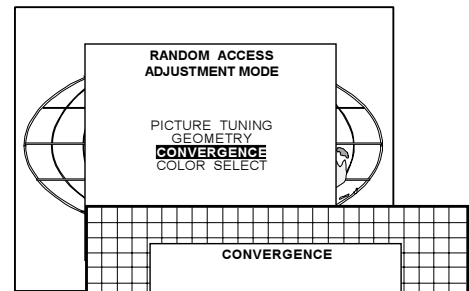

7

SERVICE MODE

Starting up the Service Mode.

Use the arrow keys to highlight **SERVICE** in the Adjustment Mode menu and then press **ENTER**.

Some items in the Service mode are password protected (when the password function is active). Enter your password to continue. All other password protected items are now also available if you stay in the adjustment mode.

ENTER continues to the Service mode main menu.
EXIT returns to the operational mode.

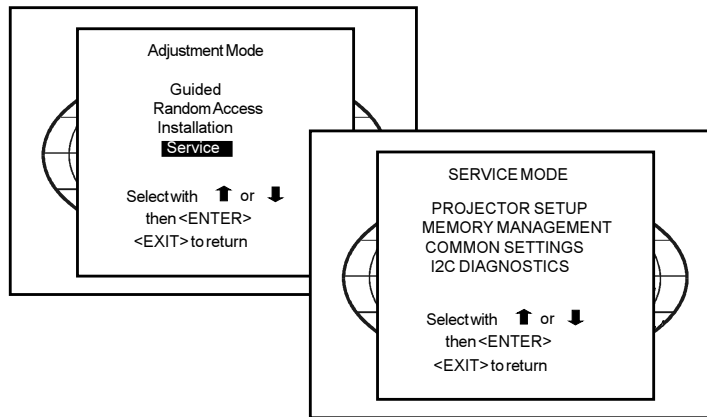

Overview flowchart SERVICE MODE.

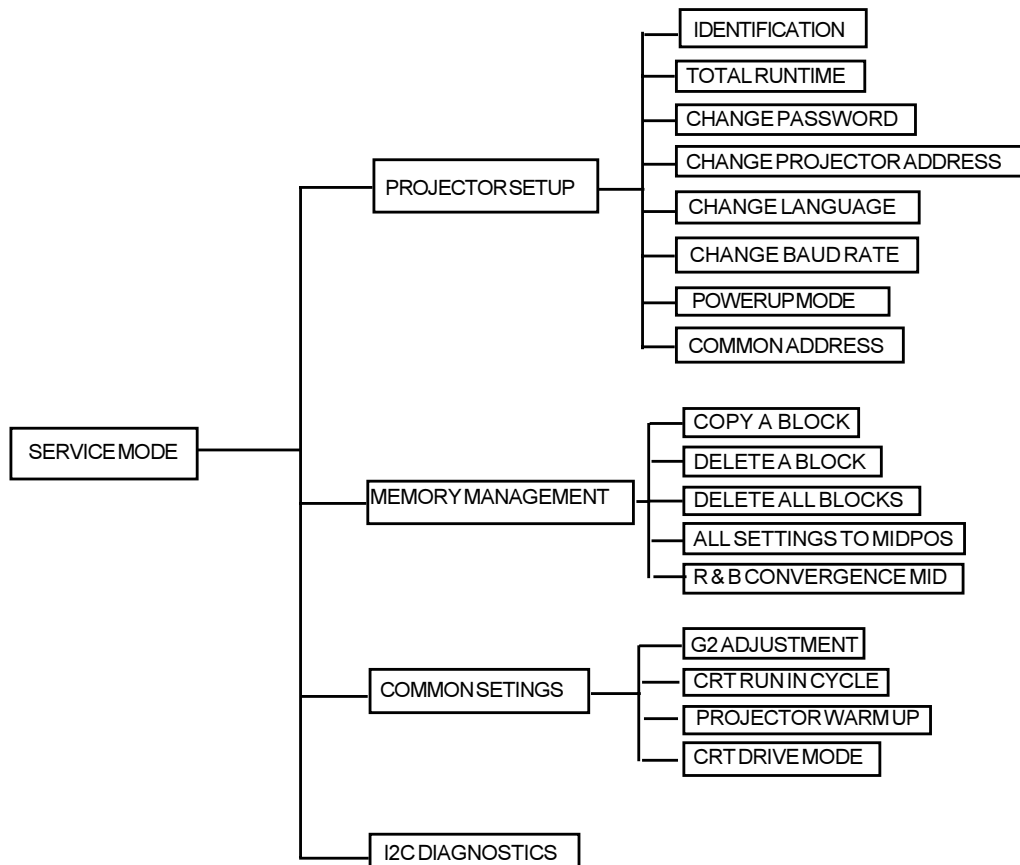

Projector Setup

Highlight **PROJECTOR SETUP** with the arrow keys and then press **ENTER**, to display the projector Setup menu.

Within the projector setup menu, the following items can be setup :

- Identification
- Total run time
- Change password
- Change language
- Change projector address
- Change baud rate
- Powerup mode
- Common address

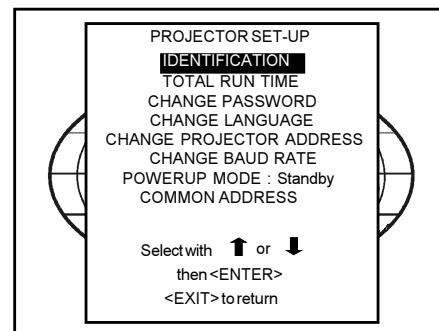
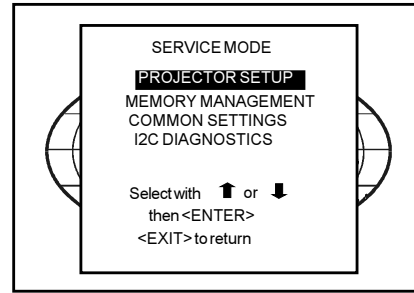

Identification

Highlight **IDENTIFICATION** using the arrow keys and then press **ENTER**.

The Identification screen displays information concerning :

- **Projector address.** : To change the address of your projector, contact a qualified service technician.
- **Software version.**
- **Configuration.**
Possible configurations :
 - Front ceiling
 - Front table
 - Rear ceiling
 - Rear table
- **Baud rate PC.** : Transfer speed for communication with an IBM PC or MAC. The Baud rate of the projector must be the same as that of the connected computer. When there is a difference, contact a qualified service technician to make the required changes.
- **Text on/off.** : Indicates in operational mode if the bar scale and value will be displayed and if warnings will be displayed.
ON : displayed
OFF : not displayed
The status can be changed by pressing the TEXT key once on the RCU.
- **Serial No.** : Indicates the manufacturing serial number of the projector. This number can be useful when technical assistance is required.

Total Run Time

Highlight **Total Run time** using the arrow keys and then press **ENTER** to display the total time the projector has run since its first start up at the factory.

EXIT returns to the Service Mode menu.

Note : All projectors leave the factory after a burn-in period of approximately 100 hours.

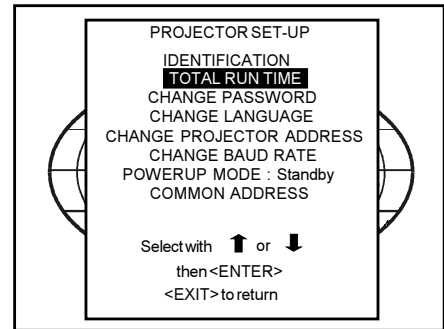

Change Password

This item is password protected.

Highlight **CHANGE PASSWORD** using the arrow keys and then press **ENTER**. The current password is displayed. The new password must consist of 4 digits, 0 to 9. Select the digit to be changed with the arrow keys and use the numeric keys to enter the new digits.

Press **ENTER** to save the new password. Before saving, a confirmation screen will be displayed.

Press **EXIT** to return to the Projector Setup menu without saving the new password.

When the displayed password is correct, press **ENTER** to save. If not correct, press **EXIT** to cancel the saving.

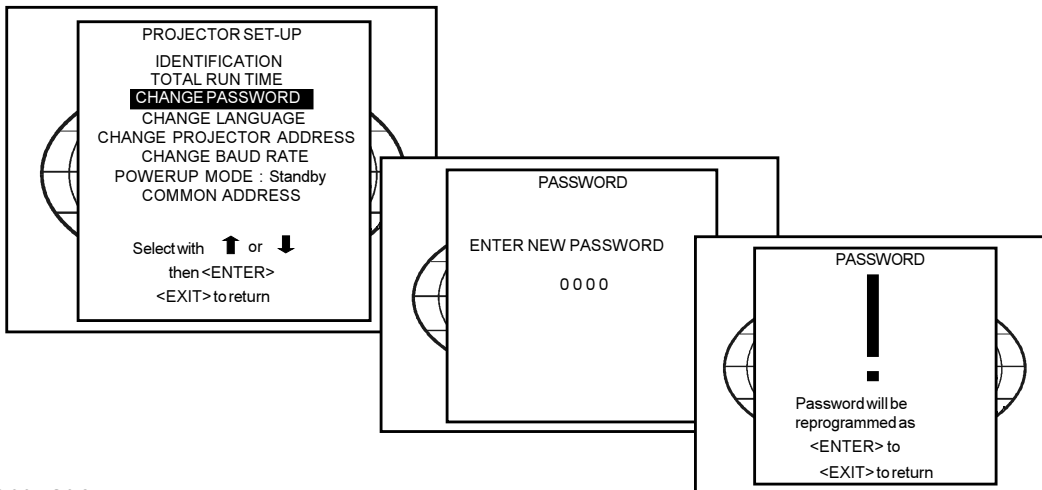

Change Language

Using the arrow keys, highlight **CHANGE LANGUAGE** and then press **Enter** to display the list of languages available for the screen displays. The following languages are available :

- English
- Spanish
- French
- Deutsch

Highlight the language of your choice and then press **ENTER**.

Pressing **EXIT** returns to the **PROJECTOR SETUP** menu.

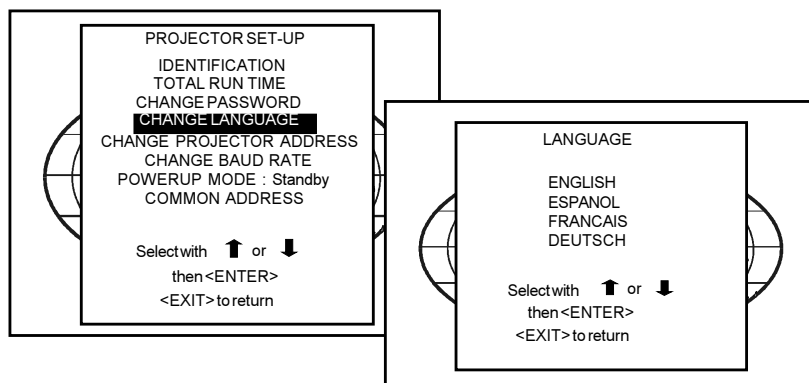

Change Projector Address

Every projector requires an individual address between 0 and 255. This address can be software installed.

To change the address, use the arrow keys to highlight **CHANGE PROJECTOR ADDRESS** and then press **ENTER**. The Change Projector Address menu will be displayed and the actual current address will be displayed. The first digit is highlighted. Select the individual digits using the arrow keys. Reprogram with the digit keys on the RCU. Press **ENTER** to confirm. Press **EXIT** to return to the **PROJECTOR SETUP** menu.

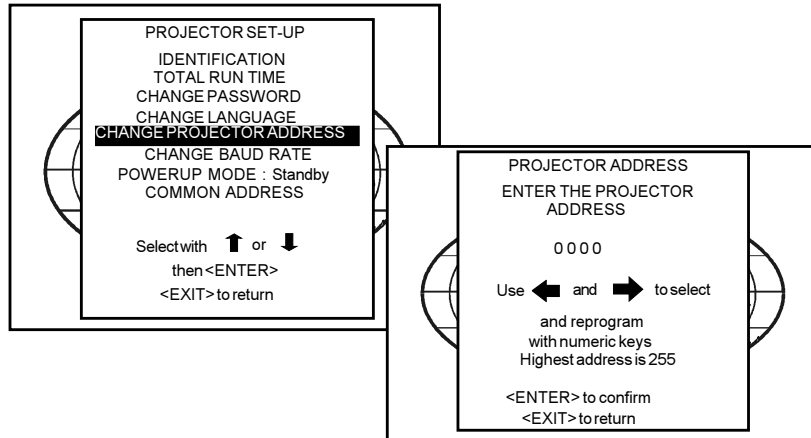

Change Baud Rate

The communication speed between projector and computer has 8 possible speeds. The baud rate can be setup through software. Highlight **CHANGE BAUD RATE** using the arrow keys and then press **ENTER** to display the baud rate selection menu. The following baud rates are available :

- 9600
- 4800
- 2400
- 1200
- 600
- 300
- 150
- 110

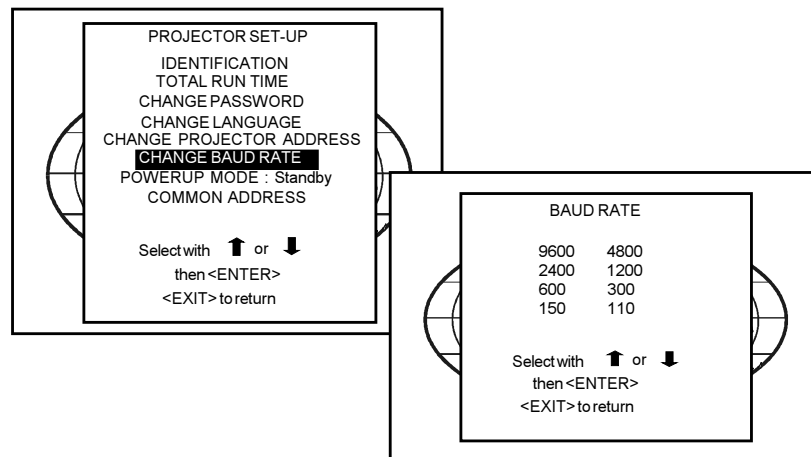

The current baud rate will be highlighted in the menu. To change the baud rate, use the arrow keys to select the desired baud rate and press **ENTER** to accept this baud rate. Pressing **EXIT** in this menu returns to **PROJECTOR SETUP** menu.

Power up Mode

When switched on from the Power switch, the projector can start up in 'Operating mode' or 'Stand-by mode'.

Operating mode : The projector starts up and displays the image.

Standby mode : The projector starts up in Standby and waits until the Standby key or a digit key is pressed.

To change the powerup mode, select **Power up** using the arrow keys and then press **ENTER** to toggle between **Operating** and **Standby**.

EXIT returns to **SERVICE** menu.

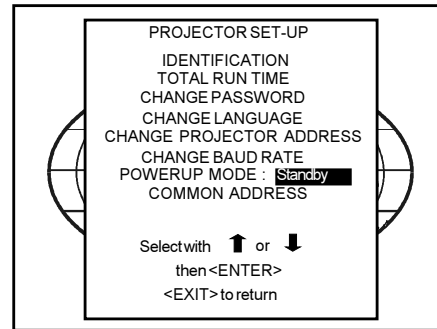

Memory Management

Highlight **MEMORY MANAGEMENT** using the arrow keys then press **ENTER** to display the **MEMORY MANAGEMENT** menu.

Within the memory management menu, the following items can be executed :

- copy a block
- delete a block
- delete all blocks
- all settings to mid position
- R & B convergence to mid

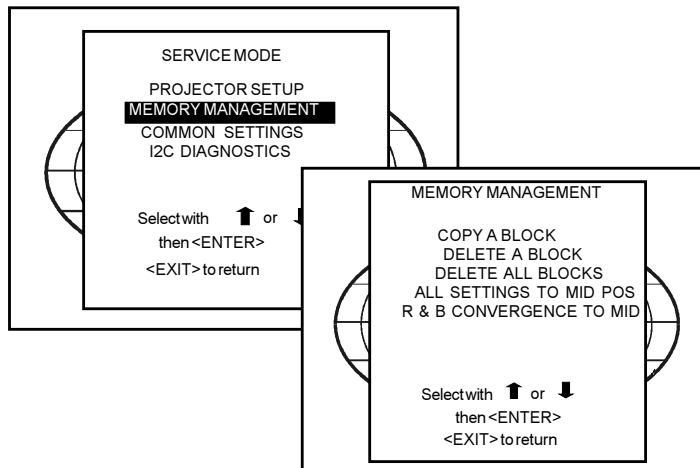

Copy a Block

The 'copy a block' function copies the settings of a selected memory block into the active block. Highlight **COPY A BLOCK** using the arrow keys and press **ENTER**. The **Copy Mode** menu is displayed.

To copy the settings of a closed block to the active block, use the arrow keys to select a block. All existing settings will be over written with the new settings. Press **ENTER** copy the selected block. A confirmation screen will be displayed. In the confirmation screen, **ENTER** executes the Copy operation and **EXIT** returns without copying the block.

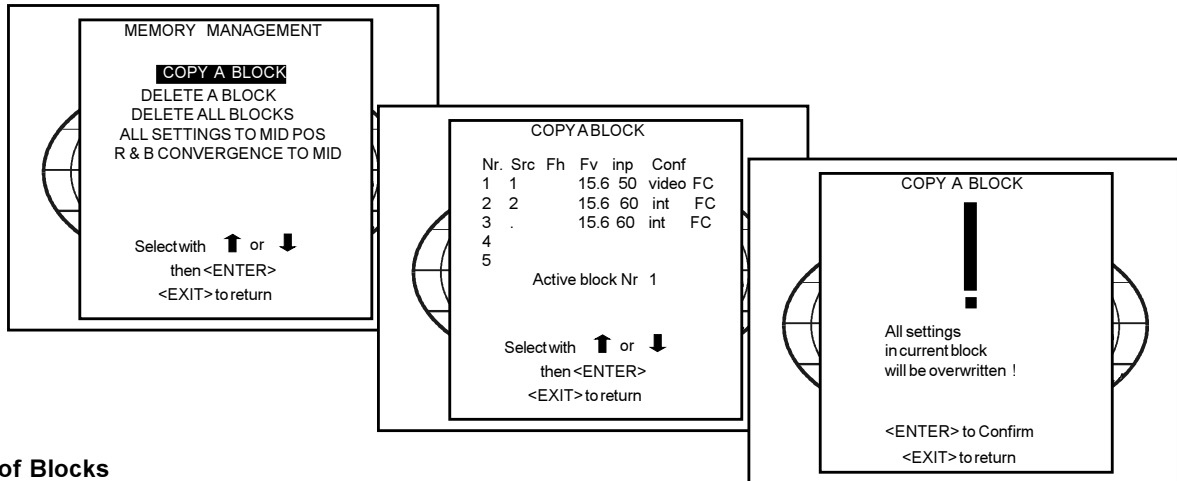

Deletion of Blocks

This item is password protected. The delete function is used to clear all data (settings) from an adjustment block.

Deletion can be done :

- block by block
- OR
- for all blocks.

Deleting block by block

Highlight **DELETE A BLOCK** using the arrow keys and press **ENTER**. Continue with the next block to be deleted. Press **EXIT** when finished to return to the Memory Management menu.

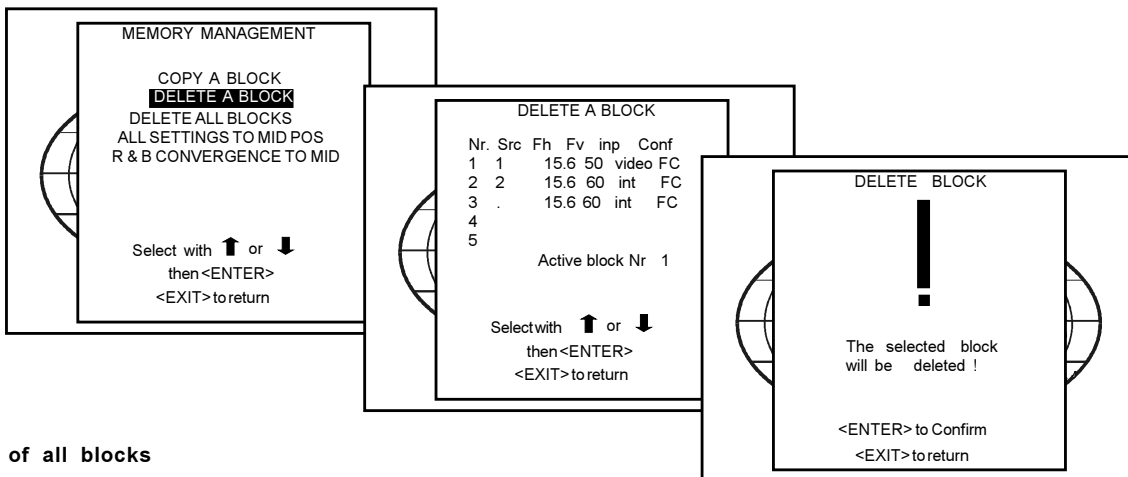

Deletion of all blocks

Highlight **DELETE ALL BLOCKS** using the arrow keys and press **ENTER**.

A confirmation screen will be displayed. Press **ENTER** to delete all blocks, or press **EXIT** to return without deleting anything.

Note : Once ENTER is pressed, all block headers and settings are permanently removed and cannot be restored.

All settings to midposition

This item is password protected.
 Highlight **All settings to midposition** using the arrow keys and press **ENTER** to set all settings to midposition.
 A confirmation menu will be displayed first.
 In this menu :

ENTER will set all settings to their midposition.
EXIT will cancel the operation.

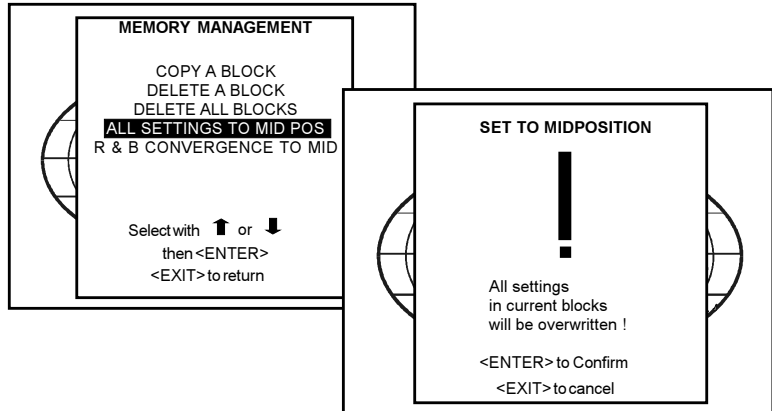

Undo all settings to midposition

When 'All settings to midposition' is selected, this action can be cancelled by selecting 'Undo all settings to midposition' in the Memory Management menu. Press **ENTER** after selecting this option.

An Undo is possible as long as the projector is on the same source (i.e. same adjustment block) even when some adjustments like geometry or convergence are readjusted. When Undo is selected, all settings are restored to their previous settings.

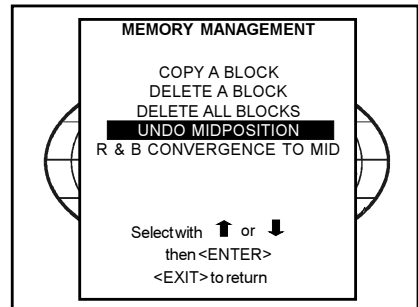

R & B CONVERGENCE MID

All convergence settings for red and blue are set to midposition.
 Item is password protected.

Push the cursor key **↑** or **↓** to highlight 'R & B Convergence Mid'.
 Press **ENTER** to select.

A confirmation screen will be displayed first.
 Press **ENTER** to confirm.

Press **EXIT** to cancel the procedure to set the convergence settings to their midposition.

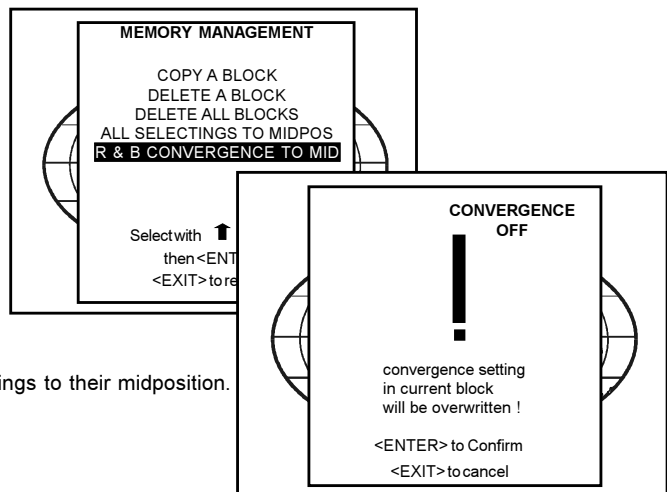

UNDO R & B CONVERGENCE MID

When "R & B convergence mid" is selected, all convergence settings are set to their midposition. With the undo, it is possible to return to the previous settings as long as the projector is playing on the same source (= same adjustment block).

'Undo R & B convergence mid' is displayed in the Memory management menu in stead off 'R & B convergence mid' when this latter is pressed.

Push the cursor key **↑** or **↓** to highlight 'Undo R & B convergence mid'.
 Press **ENTER** execute the undo function.

Again a confirmation screen will be displayed first.
 Press **ENTER** to confirm.

Press **EXIT** to cancel the procedure to set the convergence settings to their midposition.

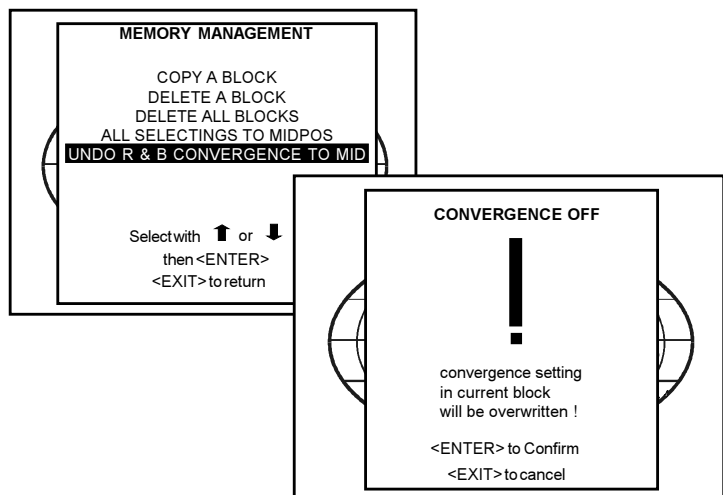

8

OPTIONS

IR Receiver 800

This infrared receiver unit makes it possible to control the projector from another room.

There is a communication line with cable between the IR receiver and the projector or the RCVDS05. The control information from the RCU can now be sent to this IR receiver.

The IR receiver 800 displays the selected source on a 7-segment display.

Order number : **R9827515**.

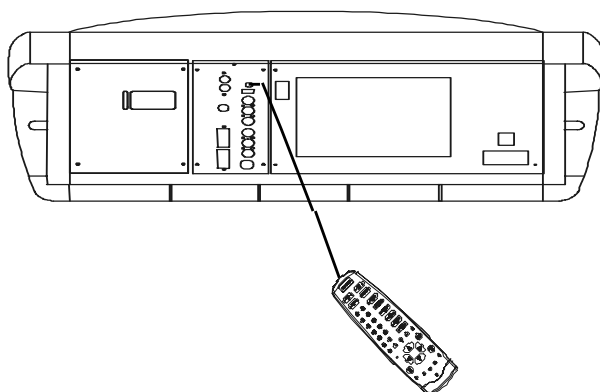
Hardwired RCU.

The control signals from the RCU can be sent to the projector via a wired connection.

Preparing your remote cable :

Use a shielded cable with a maximum length of 100 m and two mini-jack 3.5 mm connectors (order number : R313043).

- Peel back the vinyl covering of the cable on both sides and twist the wire core.
- Solder a jack plug as shown in drawing above to each end of the cable.

shield = ground

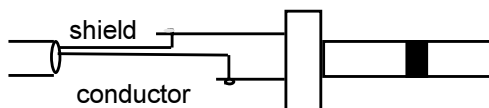

conductor = data information

When the cable is ready, plug one side in the remote control and the other side in the connector on the rear of the projector labelled '**remote**'.

RCVDS 05

An optional RCVDS 05 source selector makes it possible to connect up to 20 sources to the projector. When RCVDS's are linked via the expansion module, even 90 inputs can be connected to the projector. The selected source number will be displayed on a 2 digit display and the selected input module will be indicated with a LED on the rear.

VS05

The VS05 is a versatile Video and HDTV source selector for all BARCO's digitally controlled large screen projectors. It offers the possibility to connect and switch up to 5 different Video sources, 3 different S-Video sources and 1 RGB Analog source to a BARCO projector. In addition, the audio signal proper to the source, can be switched to an audio amplifier.

Adapter and communication cables

BARCO provides several cables to connect peripheral equipment to the projector.

a. D9-D9 communication cable

- To connect an IBM PC (or compatible) to the projector. (only if the optional RS232 port is installed.)
- To connect an RCVDS to the projector.
- To connect an IR receiver to the RCVDS05 or to the projector.
- To be used as extension cable for all other adapter cables.

Available length : 5m (16ft), order number **R982770**;
15m (50ft), order number **R9827560**;
and 30m (100ft), order number **R9827570**

b. Din Mini 8-D9 adapter cable.

- To connect a Macintosh computer to the projector.
Available length : 1 m, order number **R9827640**.

c. D25-D9 adapter cable

- To connect a workstation to the projector.
Available length : 1 m, order number **R9827630**

Ceiling mount CM50

This suspension system enables to mount any projector from the BARCO 700 series to the ceiling without using any mechanical interface, and to adapt the projector perfectly to the local mounting requirements.

Order number CM50 with pulley : **R9827990**

Order number CM50 without pulley : **R9827991**

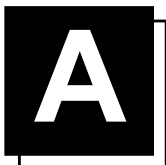

TUNER MODE

Tuner mode

With one of the four available tuner kits, it is possible to receive RF signals from a TV cable network or a TV antenna. The four kits are designed to fulfil the different Broadcasting systems worldwide.

These kits are :

Order no.	Broadcasting System	Audio Type	Teletext
R9828590	BG/L	FM - FM&NICAM	TXT
R9828600	I	FM - FM&NICAM	TXT
R9828610	MN	MTS	CC
R9828620	DK	No stereo	no TXT

FM-FM : Dual carrier FM coded discrete stereo transmissions, analogue.

NICAM : Digital two channel audio transmissions with sub-code selection of bi-lingual operation.

MTS : Used in conjunction with NTSC. Consists of two independent carriers each carrying a discrete channel. One channel provides stereo sound. The second carrier carries a Secondary Audio Program which is used for a second language or a descriptive commentary for the blind.

CC : (Closed Captioning) Transmitted on line 21 of NTSC transmissions contains subtitling information only.

Teletext : An information service of 200-700 "pages" covering a wide range of topics

How to activate the tuner mode ?

- Using the RCU.

Press the **R (star)** key. The last selected channel will be displayed.

To switch to another channel :

- push the control disk up or down
- OR**
- enter the channel number with the digit keys.

When a new channel is displayed, a text box appears on the screen with preselection number, the channel name (when entered) and the sound reproduction.

When you want to leave the tuner mode, press the BARCO key again.

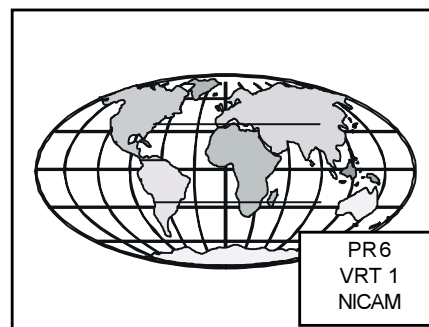

- Using the local keypad.

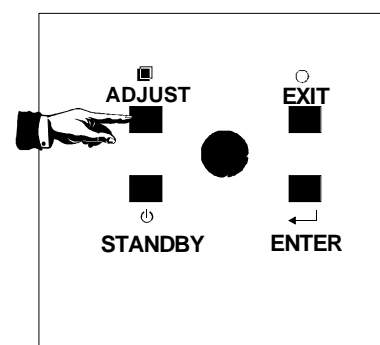

Press the **ADJUST** key.
 The projector displays the **GENERAL ACCESS** menu.
 Use the control disk to highlight **TUNER** and press **ENTER**.

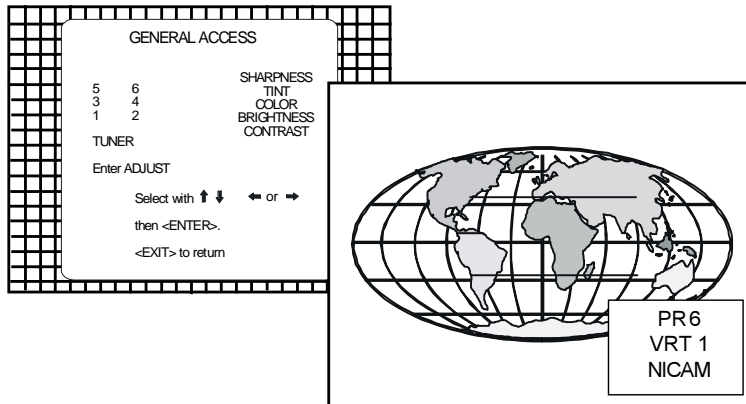

The last selected channel will be displayed.
 To switch to another channel, push the control disc up or down.

When a new channel is displayed, a text box appears on the screen with preselection number, the channel name (when entered) and the sound reproduction.

When you to leave the tuner mode, select tuner on the general access menu again and press **ENTER**.

Tuner setup

To enter 'Tuner Setup', press **ADJUST** to display the adjustment mode menu.
 Highlight '**TUNER SETUP**' by pushing the control disc up or down and press **ENTER** to display the Tuner Setup menu.

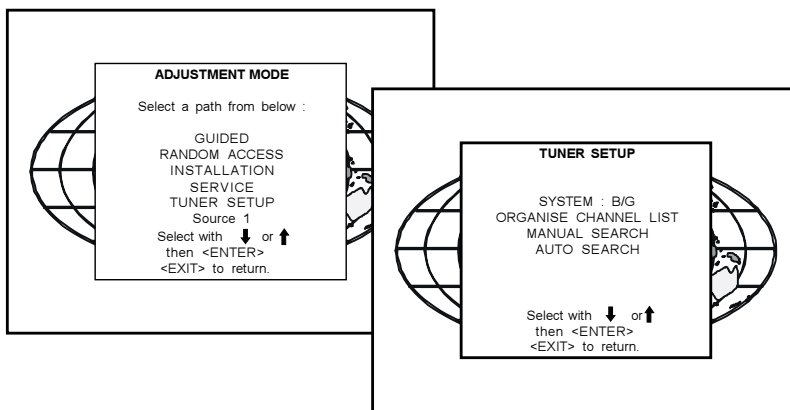

Broadcasting System

The broadcasting system is the way the signals are transmitted through the air.
 Barco designed 4 different tuners to fulfil the different broadcasting systems worldwide.

Changing the broadcasting system is only necessary for the BG/L system.

BG system : European standard.

L or L' : French standard.

To change the broadcasting system, push the control disc up or down to select 'System' and press **ENTER** to switch to a different system.

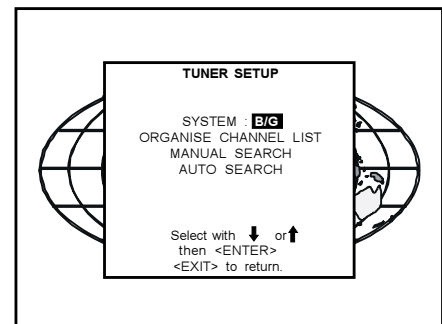

Auto Search

All channel information will be overwritten and the channel list will be reorganised completely. The projector scans the entire VHF and UHF band for the available TV frequencies. It starts in the lower frequency range and it stores each found frequency in another preselection in a consecutive order. It takes around 2 to 3 minutes to complete the entire TV spectrum.

To start auto search, push the control disc up or down to select the 'Auto Search' function and press **ENTER** to select.

A warning will be displayed that all information will be overwritten.

Press **ENTER** to confirm and to start up the auto search action.

When the first frequency is found, the auto search menu with the frequency and the preselection indication will be displayed. While this menu is visible, a projector will execute a small fine tuning for that channel.

When the entire TV spectrum is finished, the projector goes back to the beginning of the TV spectrum and when the first identical source is found, it stops.

It is possible to reorganise the channel list to your wishes and to add additional information to the channel list. See '**ORGANISE CHANNEL LIST**'.

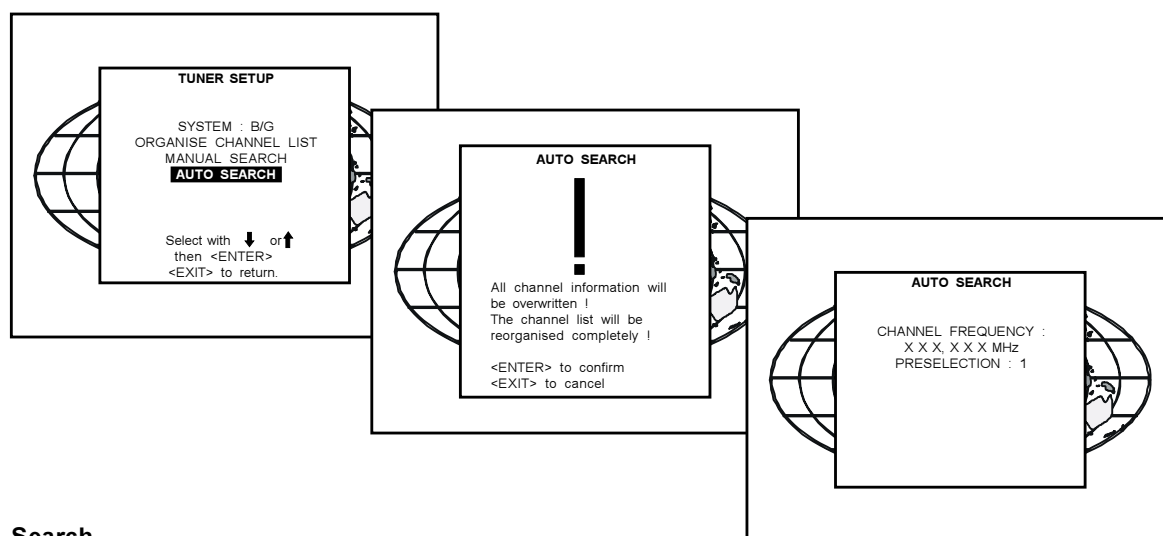

Manual Search

The desired channels can be search manually.

Highlight '**MANUAL SEARCH**' by pushing the control disc up or down and press **ENTER** to display the manual search menu. The last selected source will be displayed.

Push the control disc up or down to select the next available frequency. When a channel frequency is found, it stops and displays the frequency.

Fine tuning is possible by pushing the control disc to the right or to the left.

The preselection indication will be blinking on the next available preselection number. If this preselection is ok, press **ENTER** to store the displayed image in that program location. If another preselection is desired, press the corresponding digits with the numeric keys and press **ENTER** to store the displayed image in that program location.

Press **EXIT** to return to the 'Tuner Setup' menu.

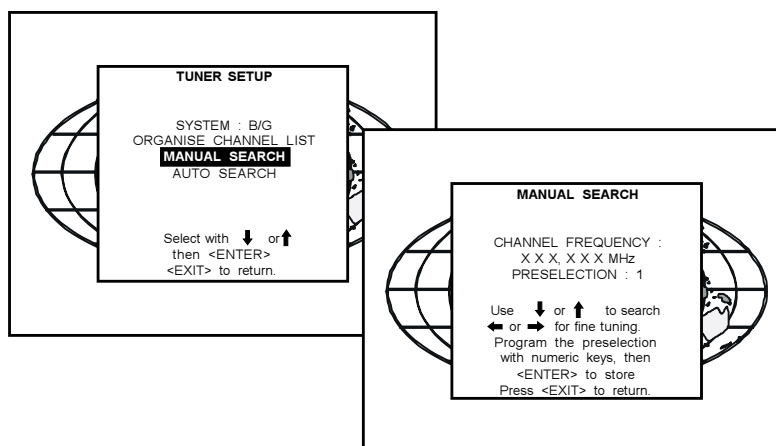

Organise Channel List

Once the TV frequencies are entered in the channel list, this list can be ordered according your own preferences. Highlight '**ORGANISE CHANNEL LIST**' by pushing the control disc up or down and press **ENTER** to select. The channel list will be displayed.

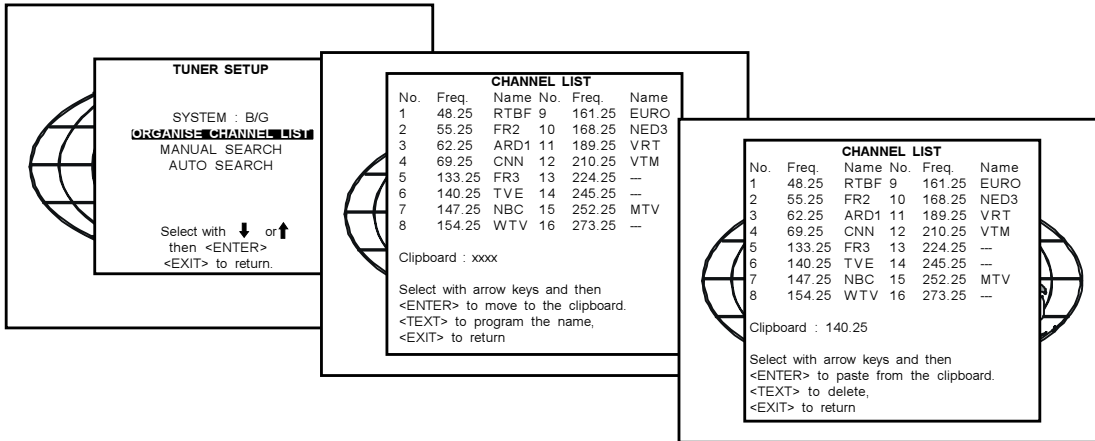

To reorganise the channel list :

- select a frequency with the control disc.
- press **ENTER** to copy this frequency to the clipboard.
- select the new location with the control disc.
- press **ENTER** to paste that frequency on the new location. All other frequencies starting from the new location will move up one position in the list.

To delete a frequency in the channel list :

- select a frequency with the control disc.
- press **ENTER** to copy this frequency to the clipboard.
- press **TEXT** to delete the selected frequency. A warning will appear on the screen. If you really want to delete, press **ENTER** to confirm. Otherwise press **EXIT** to cancel.

Next to the frequency, it is possible to fill in a name for that channel.

This name will be displayed each time this preselection is selected.

To enter a name for a channel, follow the next steps :

- select a frequency with the control disc.
- press **TEXT** to reprogram the name. The 'Compose' menu will be displayed. The first position blinks.
- select with the control disc the desired character on the displayed keyboard.
- press **ENTER** to select.
- the second position starts blinking and can be programmed in the same way. Maximum 6 position can be entered in the same way.

When the name is programmed, press **EXIT** to return to the channel list.

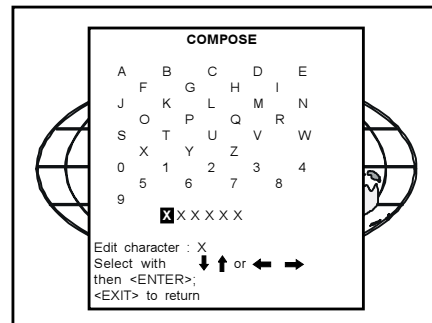

Bilingual : sound A

This menu option is only visible when a dual sound transmission is available on the selected channel. Highlight '*Bilingual: Sound A*' by pushing the control disc up or down and press **ENTER** to toggle between sound A or Sound B.

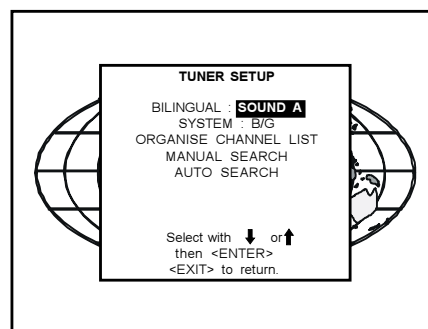

Teletext

This teletext function is only available when operating in tuner mode. To enter the teletext mode, press the **TEXT** key.

The following keys on the RCU has a function in the teletext mode :

TEXT : a 3 way toggle key



NUM key (0 ...9)

To enter directly the page numbers (3 digits), e.g. 730, press the digit 7-3-0 successively.

The number of the chosen page will appear in the top left-hand corner of the screen. The digits in the normal page number position will rotate according to the page transmission order. When the requested page number appears, the old page will be replaced by the new one.

FREEZ key

If you wish to stop temporarily the search for a page or the automatic rotation of some pages, then press the **FREEZ** key. To allow normal operation, press this button again.

ENTER key

To display a particular sub-page of a page. Select first your page.

Press **ENTER** to display at the top left corner a T followed by 4 blanks. Enter the sub-page number. E.g. sub-page 4 : enter digits 0004.

The selected sub-page will be displayed on the screen and remains on the screen. This page will frequently updated.

HELP key

To display concealed information. Some teletext pages contain concealed information such as answers to puzzles. To reveal this information press the **HELP** key.

